

# RADIO & TELEVISION RETAILING



*Push Portables for Plus Profits*

AM-FM, TELEVISION • ELECTRICAL APPLIANCES  
RECORDS & PHONOGRAPHS • SERVICING & SOUND

*Featuring* **PROJECTION TELEVISION**

**April • 1949**  
CALDWELL-CLEMENTS, INC.

Long Life on Tough Jobs is  
 One Reason Why  
**MALLORY**  
**VIBRATORS**  
 are So Popular

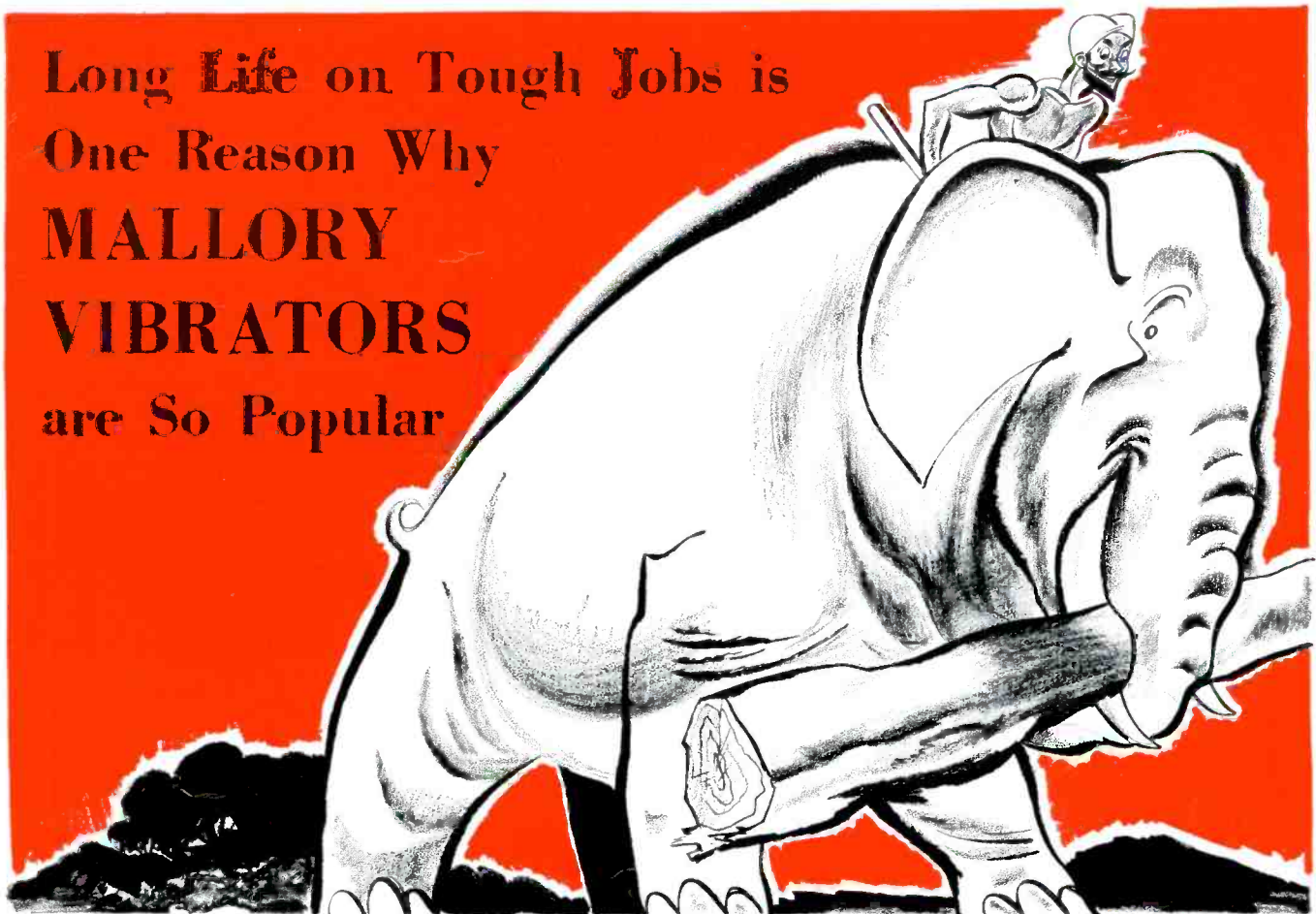

Long life in a vibrator results from a combination of good design and careful production. The design of Mallory Vibrators is a product of an unusual combination of engineering talent

and resources in electronics, electrochemistry and metallurgy.

For example, the contacts in Mallory Vibrators are Mallory-specified and Mallory-made. And a patented Mallory design insures a perfectly balanced mechanism.

Convincing proof that Mallory maintains careful production is the fact that more Mallory Vibrators are in use as original equipment than all other makes combined.

You get not only *long life*, but *dependable starting*, and *high output efficiency* from Mallory Vibrators. No wonder they are so popular with radio service men everywhere—Mallory Vibrators are best for replacements. See your Mallory Distributor.

### Mallory "2448" Vibrator Deal

This deal gives you a handsome storage and display cabinet for your stock of vibrators, together with a selection of vibrators and buffer capacitors that will answer 75% of your requirements.



You pay only the service man's net price for the six vibrators and twelve buffer capacitors. There is no charge for the attractive, convenient cabinet. Your Mallory distributor has them in stock for immediate delivery.

MORE MALLORY VIBRATORS ARE USED IN ORIGINAL EQUIPMENT THAN ALL OTHER MAKES COMBINED

**P. R. MALLORY & CO. Inc.**  
**MALLORY**

CAPACITORS . . . CONTROLS . . . VIBRATORS . . .  
 SWITCHES . . . RESISTORS . . . RECTIFIERS . . .  
 VIBRAPACK\* POWER SUPPLIES . . . FILTERS

\*Reg. U. S. Pat. Off.

**APPROVED PRECISION PRODUCTS**

**P. R. MALLORY & CO., Inc., INDIANAPOLIS 6, INDIANA**

# RADIO & TELEVISION RETAILING

Established in 1922  
as ELECTRICAL RETAILING

Including "Radio & Television"  
and "Radio & Television Today"

**ORESTES H. CALDWELL**

Editorial Director

**M. CLEMENTS**

Publisher

**JOHN L. STOUTENBURGH**

Executive Editor

**RUTH MORRIS**

Records Editor

**EDWARD A. CAMPELL**

Technical Editor

**CHARLES F. DREYER**

Art Director

## BUSINESS DEPARTMENT

**M. H. NEWTON**

Sales Manager

**EDWIN WEISL, JR.**

**JOHN ROMANCHAK**

**M. E. SCHNEIDER**

Production

## BRANCH OFFICES

CHICAGO 6

**R. Y. FITZPATRICK**, Manager

**S. GASKINS**

201 N. Wells St. Randolph 6-9225

LOS ANGELES 14

**DUANE WANAMAKER**

610 S. Broadway  
Mutual 2161

## CIRCULATION DEPARTMENT

**B. V. SPINETTA**

Circulation Director

**W. W. SWIGERT**

Credit Manager

## Radio & Television Retailing\*

April 1949, Vol. 49, No. 4, 35 cents a copy. Published monthly by Caldwell-Clements, Inc. Publication Office, 1309 Noble St., Philadelphia 23, Pa. Editorial Advertising and Executive Offices, 480 Lexington Ave., New York 17, N. Y. Subscription rates United States and U. S. Possessions \$2.00 for one year, \$3.00 for two years, \$4.00 for three years. Canada \$3.00 for one year, \$4.00 for two years, \$5.00 for three years. Pan American Countries \$4.00 for one year, \$5.00 for two years, \$6.00 for three years. All other countries \$5.00 for one year, \$7.50 for two years, \$10.00 for three years. Printed in U.S.A. Entered as second class matter February 21, 1949, at the Post Office at Philadelphia Pa., under the act of March 3, 1879. Member of Audit Bureau of Circulations.

\*Trade-Mark Reg. U. S. Pat. Off.  
Copyright 1949 by

**CALDWELL-CLEMENTS, Inc.**  
Publishers also of TELE-TECH

IN THIS ISSUE

APRIL, 1949

## ★ *AM, FM, Television*

COVER—Push Portables for Plus Profits!

(Photo by Charles F. Dreyer, art director, RADIO & TELEVISION RETAILING)

"You CAN take it with you in addition to using it any place in the home," Elting Harp, manager, Greenwich Home Appliance Company, says about that portable radio he's showing prospective customers. Subject of a feature article in a future issue of this magazine, the Greenwich Home Appliance Company, Greenwich, Conn., is an outstanding dealership, now going great guns with TV. The television department of this establishment has been known locally as "Television Center." The profitably-operated firm employs 15 people not including the servicers.

Manager Harp has the following to say about trade publications: "When we first started in business, we subscribed for four or five trade papers for our sales employes, to keep them in close touch with new developments. However, after two years experience, we find that all our needs are well covered by RADIO & TELEVISION RETAILING and one other paper. We are therefore limiting future subscriptions to these two magazines."

CONTROL OF U. S. AIRWAYS OVER A SPAN OF 25 YEARS	37
WHAT'S AHEAD—In Radios, Appliances, Records and Television	38
NEW RADIOS, TV, FM, PHONOS	40
BIG PICTURES MEAN BIG PROFITS	44
SELL EXTRA SIZE TV	48
PACKAGED PROJECTION TV	50
KEEP TV SETS SOLD VIA INSTALLATION	58
NEW PROTELGRAM SETS	60
NEW TELEVISION RECEIVERS	65
HOW TO COPE WITH PRICE-CUTTING COMPETITION	66
SAVE MONEY ON TV SERVICING	68
HOW TO CHARGE FOR PROFITABLE SERVICING	70
COMMENTS ON THE UHF CONTROVERSY	82

## ★ *Records, Phonographs, Accessories*

COVER—RCA Victor's Record Playing System	73
MAKE DISC SALES BLOOM IN THE SPRING	76
NEWS OF THE RECORD INDUSTRY	78

## ★ *Electrical Appliances*

COVER—Show-Place Store Sells More	85
NEW ELECTRICAL APPLIANCE PRODUCTS	88

## ★ *Servicing and Sound*

COVER—Protelgram Installation, Service	94
LP RECORD CHANGERS	98
TV ANTENNAS, ACCESSORIES	100
NEW SERVICE AIDS	100
INDUSTRY NEWS	Begins on page 80

Photo Credits

Ewing-Galloway

68

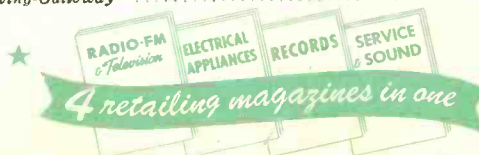

Member of  
AUDIT BUREAU  
OF CIRCULATIONS

**CALDWELL-CLEMENTS, INC.**  
480 Lexington Ave., New York, N. Y.

# First in advertising volume during each of the post-war years

These charts show the ten leading newspapers in advertising volume for the past three years

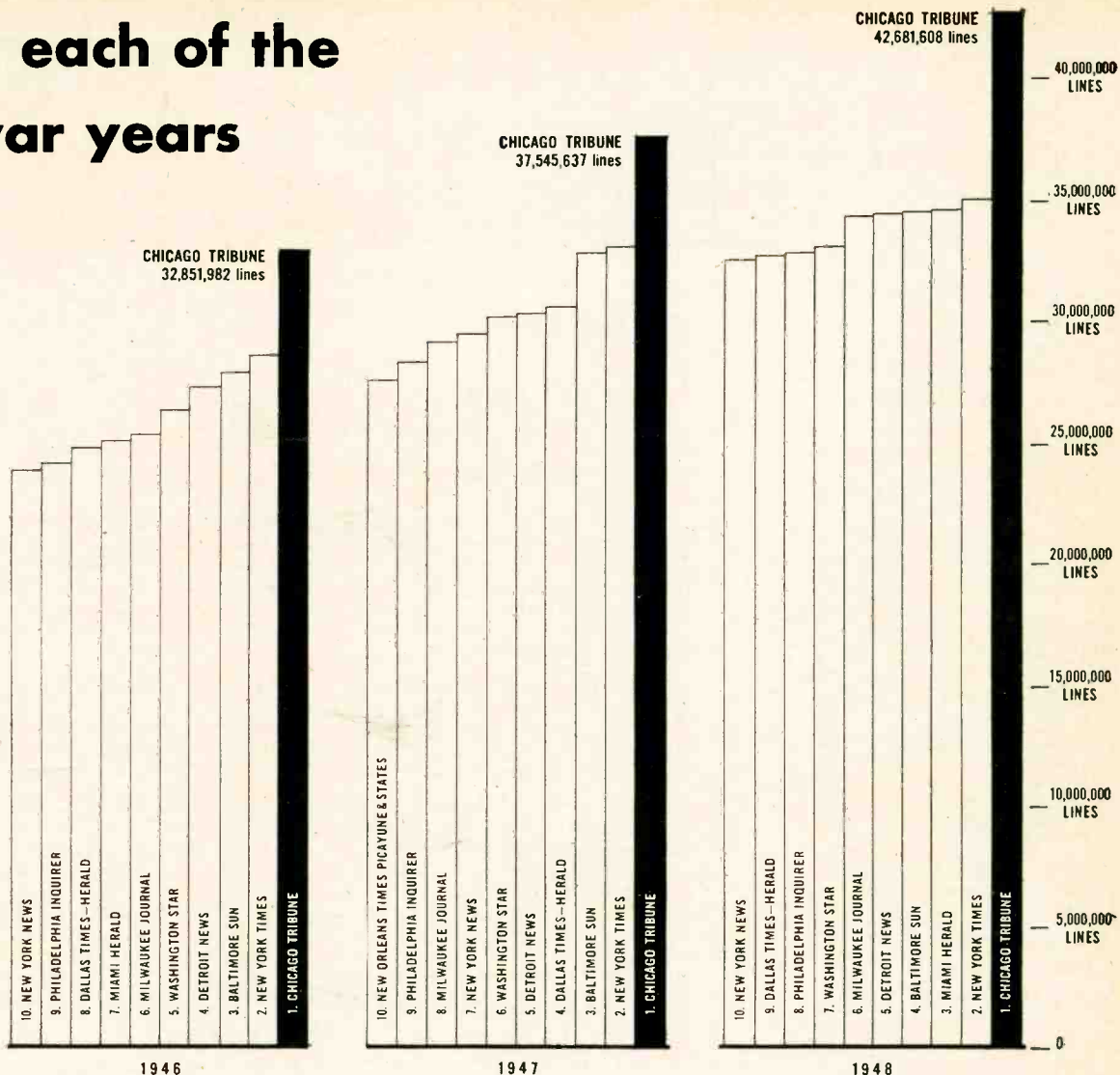

**As selling gets tougher, advertisers make plain the importance of the multi-billion dollar Chicago market—and of the Chicago Tribune's ability to develop sales here**

SHOWN in the charts is the total advertising linage carried during each of the past three years by the ten newspapers in the United States which led all others in advertising volume.

In 1946, the first full post-war year, the attractions of the market delivered by the Chicago Tribune stepped this newspaper into first place with a lead of 4,350,491 lines over the next newspaper in the country.

In 1947, advertisers testified to the results they were getting from this newspaper by boosting its lead over the next newspaper to 4,489,427 lines.

In 1948, they reaffirmed the Chicago Tribune's status as a business-producer by hiking its lead over the next newspaper to the whopping margin of 7,608,190 lines.

In doing so, they placed in the Chicago Tribune more lines of advertising than any newspaper—or any other publication in the world—ever before printed in one year.

They spent for this record-breaking volume more than

they spent in any other medium in the country, with the exception of two magazines and two radio networks.

Here is fresh evidence of the importance placed by advertisers on the buying power and responsiveness of the multi-billion dollar Chicago market—and of the effectiveness and economy with which the Chicago Tribune enables them to develop sales here.

To sell more today—and to build solidly for the future—see that your Chicago Tribune schedule is an adequate one. Rates per line per 100,000 circulation are among the lowest in America.

## Chicago Tribune

THE WORLD'S GREATEST NEWSPAPER

February average net paid total circulation:  
Daily, Over 950,000—Sunday, Over 1,650,000



MODEL No. 9G42



MODEL No. 9G40

Presenting  
*The Windsor* and  
*The Imperial*

...two brilliant new

# RECORDIO

T.M. REG U.S. PAT. OFF.

*Recording*

## RADIO-PHONOGRAPHS

Here are two exquisite additions to the famous RECORDIO line of fine home recording instruments. Featuring the same electronically perfect chassis, the "Windsor" and the "Imperial" are encased in tastefully designed cabinets. Both models provide *complete* home entertainment—recording from microphone or "off the air"—*plus* a superb AM-FM radio and an excellent automatic phonograph. Yet they both sell within the price range of ordinary radio-phonograph combinations. Ask your distributor to tell you more about the "Windsor" and the "Imperial!"



MODEL No. 9G42  
 (shown above) comes in a rich mahogany finish. Provides ample storage space for record albums. Cabinet dimensions: 36" high, 31" wide, 17 1/4" deep.



MODEL No. 9G40  
 (shown above) is available in choice of blonde or mahogany finish. Cabinet dimensions (32 3/4" high, 26 3/4" wide, 18" deep) make it ideally suited for small apartments or wherever space is limited.

KEEP YOUR EYES OPEN FOR

**TV by WG**

It's On the Way—America's Newest  
 Television—by Wilcox-Gay!

**WILCOX-GAY CORPORATION, CHARLOTTE, MICH.**

In Canada: Canadian Marconi Company

# Expected Changes in Wavelengths will not Obsolete Zenith Television

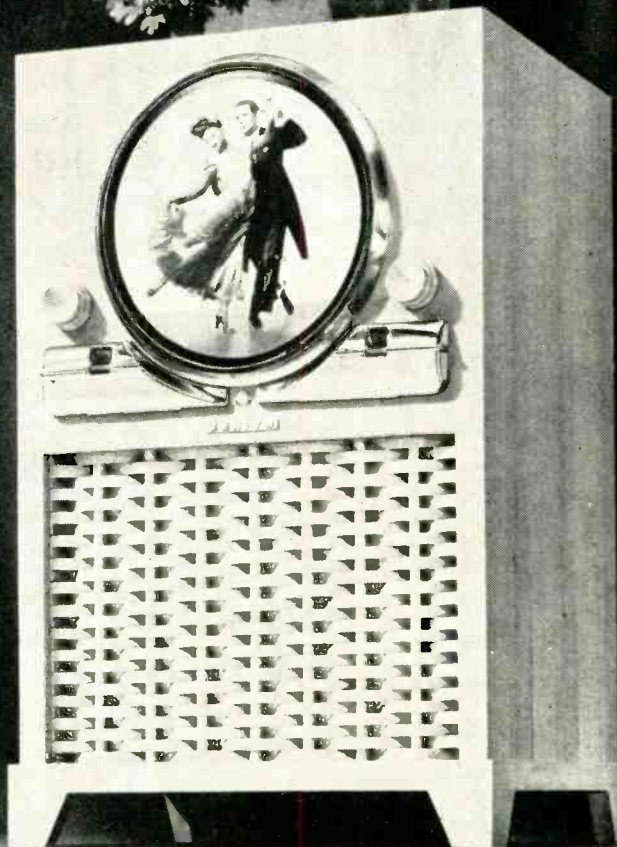

## Some facts the Public is entitled to know

In a published letter written in the public interest by Senator Edwin C. Johnson, Chairman of the Senate Committee on Interstate and Foreign Commerce, dated February 15, 1949, to the Honorable Wayne Coy, Chairman of the Federal Communications Commission, Senator Johnson said among other things:

Quote: "Also, we are concerned deeply with respect to the marketing of television sets. Television-set manufacturers and spokesmen for some broadcasters have repeatedly declared that present-day sets will not be outmoded in the near future. Nevertheless, it appears obvious to us that when and if licensing is authorized in the ultra-high-frequencies and television develops in those frequencies, television sets being manufactured today will be obsolescent. While it is contended that an attachment can be made which will meet such a contingency, in part, we are not greatly impressed with the efficacy of similar attachments for FM frequency shifts. We note that no purchaser of a television set today is warned or advised that such an attachment may be necessary or, in fact, that in a matter of a few months or years, the set for which he is paying \$200 to \$1,000 may be junk. We wonder, therefore, if some action cannot be taken by the Federal Communications

Commission which would result in set-manufacturers making clear to such buyers that caveat emptor should not enter into the purchase of such a highly complex and intricate mechanism as a television set.

"We understand that the Federal Communications Commission has no present legal authority to compel such action. If the Commission is of this opinion also, or that suggestions to television manufacturers to correct this practice may fall on deaf ears, we would appreciate recommendations for legislation to meet this problem. The public requires protection." Unquote.

Chairman Wayne Coy, by direction of the Federal Communications Commission, in responding to Senator Johnson's letter on February 25th, said among other things:

Quote: . . . "The 12 channels presently available for television are not nearly enough to take care of the demand." \* \* \* \* "Of course, if ultra high channels are added there will be some obsolescence. To be sure, converters can readily be made, which will alleviate the matter somewhat, but as recognized in your letter converters are not as satisfactory as regular receivers." End of quote.

In its May, 1945, published report the Federal Communications Commission stated, ". . . there is sufficient spectrum space available below 300 megacycles to make possible a truly nation-wide and competitive television system . . . development of the upper portion of the spectrum is necessary for the establishment of a truly nation-wide and competitive television system."

In a public notice issued on May 5, 1948, the FCC reiterated its opinion of May, 1945, and pointed out that the 475-890 megacycle band would have to be used for television if this country were to have a nation-wide competitive system of television.

So public notice has been given by FCC.

### FOR YOUR INSURANCE

EVERY Zenith television receiver is equipped with a specially designed built-in turret tuner with provision for receiving the proposed new ultra high frequency channels on the present standards.

With Zenith television no "converter" will be needed for proposed new ultra high channels.

**ZENITH RADIO CORPORATION**

Chicago 39, Illinois

Here from  
PHILCO...

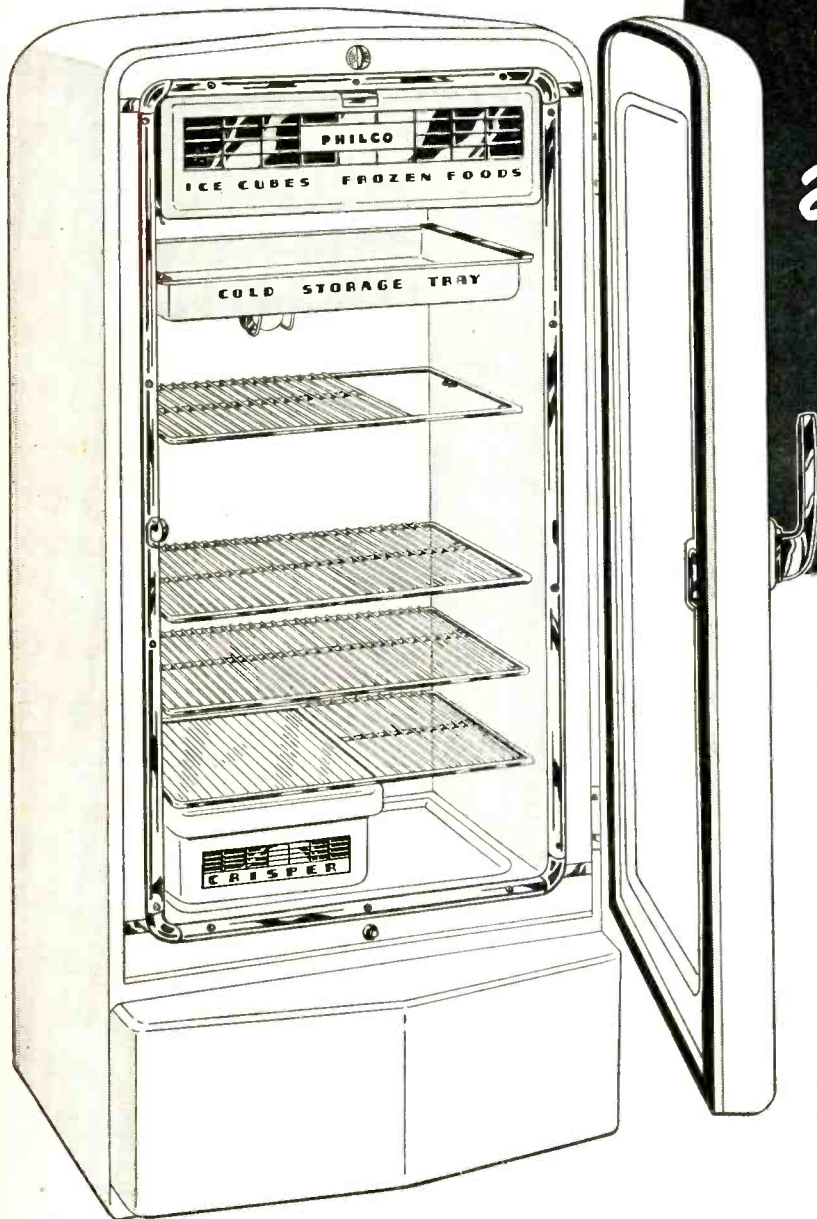

PHILCO  
MODEL 793

**\$229.50**  
\*IN ZONE 1

A FULL WIDTH  
FROZEN-FOOD  
COMPARTMENT  
at \$70 to \$100 less  
than last year's  
price!

**Yes... a Revolution in  
Refrigerator Design  
at the Lowest Price**

THE day of the "strip box" is gone! For the first time in refrigerator history Philco brings to the buying public **ADVANCED** features at the lowest price! The first refrigerator ever produced for the mass market with the greatest deluxe feature in the business today... a full width horizontal frozen food compartment! The biggest, *most usable* food storage capacity ever offered in its size and at its price! The most *different looking* low price refrigerator... unequalled in *wanted* features, in value, in promotional power. Nothing like this new Philco 793 has ever been seen... at *any* price. At \$229.50\*, it's a revolutionary achievement of Philco leadership in refrigerator design, value and merchandising.

14 SQ. FT. OF SHELF CAPACITY...  
7.2 CU. FT. FOR STORAGE OF FOOD  
ALL IN THE FLOOR SPACE OF A "4"

SEE IT NOW AT YOUR PHILCO DISTRIBUTOR

**PHILCO**

*Famous for Quality the World Over*

Here's

# PROOF!

**The Polaroid®  
Television Filter is  
Television's indispensable  
fastest-selling accessory**



### distributors

**say:**

- "...it's television's fastest repeat seller!"  
Dave Wagman,  
Bruno—New York, Inc.
- "...the greatest profit-maker in television history!"  
Bill Cone, Krich-Radisco, Inc.  
Newark
- "...even small dealers reorder weekly!"  
Wm. L. Whitehead, Interstate Supply Company, St. Louis
- "...the Polaroid Television Filter is backed by the hardest-selling, most intensive sales-promotion job in the business!"  
William Strandwitz, Raymond Rosen & Co., Inc. Phila.
- "...best selling most profitable accessory!"  
Ned Corbett, R.C.A. Victor Distg. Corp. Chicago

### dealers

**say:**

- "Sold 84 Polaroid Television Filters in 3 days."  
L. B., Newark
- "All our customers insist on the genuine Polaroid Television Filter, won't accept a substitute, no matter how cheap."  
D. J., Cleveland
- "Sold 29 Polaroid Television Filters one day, 38 the next."  
J. N., Boston
- "Tests prove it works wonders and our customers like it!"  
A. D., New York
- "Sold 75 Polaroid Television Filters in 2 days."  
N. T. D., Buffalo

Smart merchants everywhere report the Polaroid Television Filter their fastest-moving profit maker. It does what no other can do. Not just colored plastic—it is Polaroid—the greatest name in glare control . . . brings genuine visual comfort.

Stock and display the Polaroid Television Filter and you tie in with its overwhelming consumer acceptance and its hard-hitting advertising and promotion. There's a Polaroid Television Filter for every set—sensibly priced within the reach of all:

- No. 700—for all receivers with 7" tubes.....\$ 6.50
- No. 1000—for all receivers with 10" tubes.....\$10.00
- No. 1200—for all receivers with 12" tubes.....\$12.50
- No. 1500—for all receivers with 15" tubes.....\$16.00
- No. 2000—for all receivers with 20" tubes.....\$25.00
- No. 3000—projection model.....\$27.50

### CALL OR WRITE THE DISTRIBUTOR IN YOUR AREA:

NEW YORK CITY: BRUNO — NEW YORK, INC., 460 WEST 34th STREET • ALBANY: R. T. A. DISTRIBUTORS, INC., 36 BROADWAY • HARTFORD: RADIO & APPLIANCE DISTRIBUTORS, INC., 673 CONNECTICUT BLVD. • PHILADELPHIA: RAYMOND ROSEN & COMPANY, INC., 32nd & WALNUT STREETS • CHICAGO: R. C. A. VICTOR DISTRIBUTING CORP., 445 NO. LAKE SHORE DRIVE • CINCINNATI: OHIO APPLIANCES, INC., 659 E. SIXTH STREET • DAYTON: OHIO APPLIANCES, INC., 430 LEO STREET • CAMBRIDGE: THE EASTERN COMPANY, 620 MEMORIAL DRIVE • NEWARK: KRICH-RADISCO, INC., 422-432 ELIZABETH AVENUE • WASHINGTON: SOUTHERN WHOLESALERS, INC., 1519 L STREET N. W. • BALTIMORE: D & H DISTRIBUTING COMPANY, INC., 31-37 E. LEE STREET • ST. LOUIS: INTERSTATE SUPPLY COMPANY, 10th & WALNUT STREETS • CLEVELAND: GOLDHAMER, INC., 2239 EAST 14th STREET • MILWAUKEE: TAYLOR ELECTRIC COMPANY, 112 N. BROADWAY • MINNEAPOLIS: F. C. HAYER CO., 300 WASHINGTON AVENUE N. • TOLEDO: MAIN LINE DISTRIBUTORS, 374 ERIE STREET • BUFFALO: PROGRESS DISTRIBUTING CORP., 151 GENESEE STREET • DETROIT: R. C. A. VICTOR DISTRIBUTING CORP., 1930 E. JEFFERSON STREET • WEST COAST: HAROLD B. SHOMLER (MFG. REP.) 3543 ANGELUS AVE., GLENDALE, CALIF.

A PRODUCT CREATED BY

## PIONEER SCIENTIFIC CORPORATION

295 LAFAYETTE STREET, NEW YORK 12, N. Y.

® by Polaroid





RADIO AND TELEVISION TUBES

**"THEY SELL FAST AND STAY SOLD!"**

**Y**OU have the word of other experienced servicemen for it—Ken-Rad tubes are a fast-turnover line. And they give satisfaction. They make friends for your shop.

By word-of-mouth endorsement alone, Ken-Rad tubes will gain a good name in any locality. They're a quality product, a better tube . . . and such news gets around!

But there's a faster way to bring Ken-Rad dependability to the notice of your customers. *Advertise!* Ken-Rad makes it easy for you. See the counter displays shown on this page.

In a jiffy you can put one, or both, of these attention-getters where people coming into your store are sure to see them. Also, the Ken-Rad wall plaque, decal, and giant tube carton will help identify your premises. There are blotters, postcards, stationery, repair stickers—many other aids to sales that up-and-coming servicemen have found effective. Ken-Rad's new shop coats and uniforms already are a smash hit!

Phone or write your nearby Ken-Rad distributor. He will be glad to show you how Ken-Rad radio-TV tubes—a profitable

line—*can be made more so* by taking full advantage of Ken-Rad's streamlined promotion helps!



**KEN-RAD** *Radio Tubes*

PRODUCT OF GENERAL ELECTRIC COMPANY

Schenectady 5, New York

say servicemen everywhere.



KEN-RAD'S LIVE LINE OF PROMOTION PIECES HELPS TO KEEP SALES HIGH. YOUR CASH REGISTER WILL CHIME APPROVAL OF THESE NEW HIGH-OCTANE COUNTER CARDS.

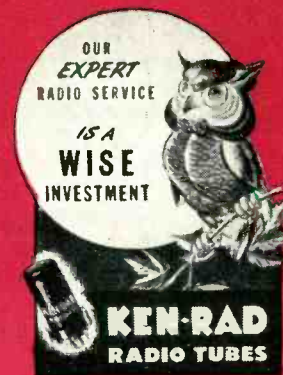

In full colors, varnished for extra brilliancy, the cards have a fast getaway that draws the customer's eye. Also, they feature the service you sell, not just the tubes! Supplied with built-in folding easel mounts.

ASK YOUR KEN-RAD DISTRIBUTOR TO DESCRIBE THE MANY OTHER SALES AIDS AVAILABLE!

*The Serviceman's Tube*

192 HA-3

# Sales ARE "BUZZING" on This Busy Line!

In February and March alone, the Kellogg SELECT-O-PHONE advertisements you see here will reach more than 2,691,394 readers . . . the great percentage of them in the executive and management groups. These are *your* prospects, the kind who are always on the lookout for ideas and equipment that will improve their companies'

operations. By explaining how SELECT-O-PHONE does *just that*, through *extra features* and more service, these ads pave your way to easy sales and profits. In 1949 SELECT-O-PHONE will be *the busy line* all year . . . generously supported by powerful advertising. It's the easiest line for you to install and maintain, too. Cash in!

NATIONAL ADVERTISING LIKE THIS MAKES SELECT-O-PHONE a BIG PROFIT MAKER FOR YOU

FORTUNE

How a Typical Company Is Saving Dollars with SELECT-O-PHONE

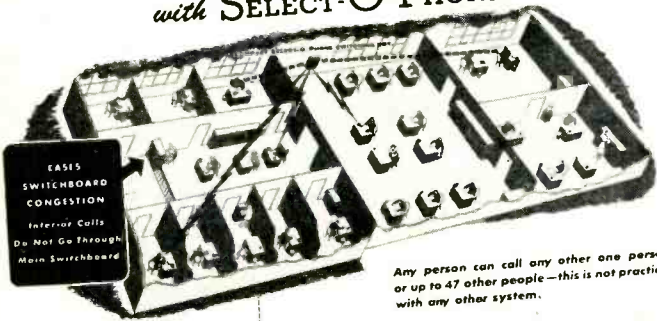

How Select-O-Phone Improves Customer Service  
Support a customer calls you for information about a particular job. You hold him on the outside line. He calls a plant foreman on the SELECT-O-PHONE. In a few seconds you have the information, and can give it to the customer without the inconvenience and delay of a call-back.

Switching Unit Is Compact—Wall-Mounted  
Switching equipment requires no special room, operators are better-served—can be wall-mounted. No expensive wire plan or cabling is needed. Both installation and maintenance are amazingly small. Switching unit will handle up to 48 stations.

SELECT-O-PHONE DIVISION  
KELLOGG SWITCHBOARD AND SUPPLY COMPANY  
6650 SOUTH CICERO AVENUE, CHICAGO 26, ILLINOIS

Any person can call any other one person or up to 47 other people—this is not practical with any other system.

Your switchboard can no longer get tied up with inside calls. When you install your own SELECT-O-PHONE Private Automatic Telephone System, surveys of actual installations show the system will handle from 25 to 50% of your total private calls! Without attention by any operator!

SELECT-O-PHONE offers you a prime advantage over other systems. Every telephone is a "master station." Any one person can call any other person, or initiate a conference call with any number of people connected in the system.

Your SELECT-O-PHONE for itself in savings of up to 40% over the cost of other switchboard equipment to spread over 10 years. SELECT-O-PHONE reducing outside calls to a better control over your switchboard.

- SELECT-O-PHONE is the only system which permits an unlimited number of simultaneous conversations—there can be no busy signals in the switching equipment. If you dial a number and receive a busy signal, it can only mean that the person you're calling is busy with another system. It could also mean that the person you're calling is busy with another system.
- Every conversation is confidential—and there are no loudspeakers for visitors in your office to overhear. "Near-echo" microphone station with loudspeaker is optional.
- If you receive no answer to a call, you will bring the man you want to call.
- SELECT-O-PHONE System is built by Kellogg—quality telephone communications equipment for your quarter of long, trouble-free service.

FACTS, FIGURES and ANSWERS  
*flow faster*



CHANGES AN "ORGANIZATION" INTO A "TEAM"  
KELLOGG SELECT-O-PHONE  
AUTOMATIC PRIVATE TELEPHONE AND PAGING SYSTEM

Printing a largely a "service" industry, customers want answers and want them fast! Kellogg's new Select-O-Phone System lets you run your business more efficiently, more quickly, for better customer service. It keeps you moving through your office on coordinated and efficient telephone lines. Select-O-Phone is a true automatic telephone system. It takes up to 50% of the load of all those intercom and "inside" calls. It permits unlimited simultaneous conversations, every one private and every one confidential. It takes no operator time.

MAIL THE COUPON FOR FULL DETAILS

SELECT-O-PHONE DIVISION  
KELLOGG SWITCHBOARD AND SUPPLY COMPANY  
6650 SOUTH CICERO AVENUE, CHICAGO 26, ILL.

NAME \_\_\_\_\_  
COMPANY \_\_\_\_\_  
ADDRESS \_\_\_\_\_  
CITY \_\_\_\_\_ STATE \_\_\_\_\_

TIME U.S. NEWS BUSINESS WEEK FORBES MODERN INDUSTRY OFFICE MANAGEMENT TEXTILE WORLD

INDUSTRIAL EQUIPMENT NEWS NEW EQUIPMENT DIGEST ELECTRICAL EQUIPMENT

FACTS, FIGURES and DECISIONS



flow faster



KELLOGG SELECT-O-PHONE  
AUTOMATIC PRIVATE TELEPHONE AND PAGING SYSTEM

Choosing your own responsive Select-O-Phone System is like having your own "assistant" at every working desk. You spend more time working and less time waiting. Fewer errors and delays. More flow rates—and the whole business goes smoother.

Select-O-Phone is a true automatic telephone system. It takes up to 50% of the load of all those intercom and "inside" calls. It permits unlimited simultaneous conversations, every one private and every one confidential. It takes no operator time.

You get no more. You get the system you want. It takes 25 to 50 percent of the load of your switchboard. Simple to install.

MAIL THE COUPON FOR FULL DETAILS

SELECT-O-PHONE DIVISION  
KELLOGG SWITCHBOARD AND SUPPLY COMPANY  
6650 SOUTH CICERO AVENUE, CHICAGO 26, ILL.

NAME \_\_\_\_\_  
COMPANY \_\_\_\_\_  
ADDRESS \_\_\_\_\_  
CITY \_\_\_\_\_ STATE \_\_\_\_\_

FACTS, FIGURES and DECISIONS  
*flow faster*



CHANGES AN "ORGANIZATION" INTO A "TEAM"  
KELLOGG SELECT-O-PHONE  
AUTOMATIC PRIVATE TELEPHONE AND PAGING SYSTEM

Printing a largely a "service" industry, customers want answers and want them fast! Kellogg's new Select-O-Phone System lets you run your business more efficiently, more quickly, for better customer service. It keeps you moving through your office on coordinated and efficient telephone lines. Select-O-Phone is a true automatic telephone system. It takes up to 50% of the load of all those intercom and "inside" calls. It permits unlimited simultaneous conversations, every one private and every one confidential. It takes no operator time.

MAIL THE COUPON FOR FULL DETAILS

SELECT-O-PHONE DIVISION  
KELLOGG SWITCHBOARD AND SUPPLY COMPANY  
6650 SOUTH CICERO AVENUE, CHICAGO 26, ILL.

NAME \_\_\_\_\_  
COMPANY \_\_\_\_\_  
ADDRESS \_\_\_\_\_  
CITY \_\_\_\_\_ STATE \_\_\_\_\_

GRAPHIC ARTS MONTHLY

Distributorships in Some Territories Still Available. Write or Wire Today For Full Details.

**KELLOGG** SWITCHBOARD AND SUPPLY COMPANY  
SELECT-O-PHONE DIVISION  
6650 SOUTH CICERO AVENUE • CHICAGO

# Emerson Radio

# America's No. 1 Portable Line!

Never before in Emerson's history of leadership in Portable values has a line been offered with such sales and profit possibilities. Never before such style, tone, performance, at such sensationally low prices. Never before a line backed with such powerful promotions. If you're looking for new Portable sales records, concentrate on Emerson.

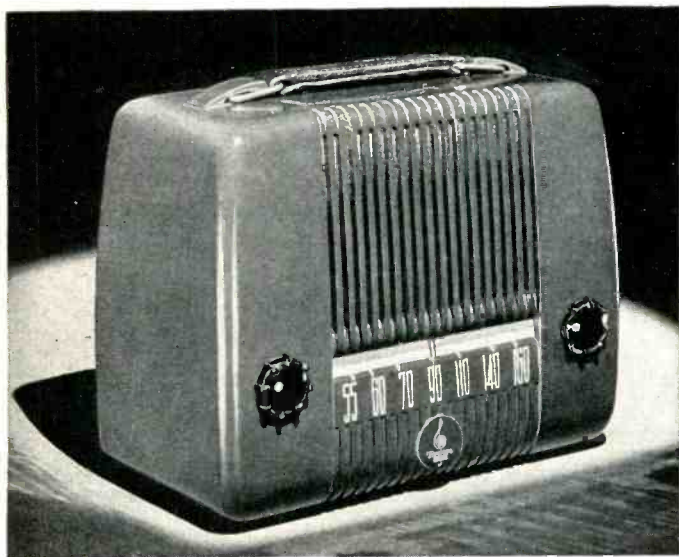

**America's Greatest Portable Value!**

**Emerson  
Model 560**

**16<sup>95</sup>**  
*less batteries*



Self-powered, Superheterodyne—beautifully engineered into a light, compact, handsome maroon or green plastic cabinet—flawless tone, sensitive circuit designed for low battery drain. A really terrific value!

**EMERSON 3-WAY PORTABLE  
Model 559**

**24<sup>95</sup>** *less batteries*

Operates on AC-DC, or self-contained batteries. Extra power, beautiful tone...no distortion. Alligator-grained plastic cabinet in maroon, green or sand.

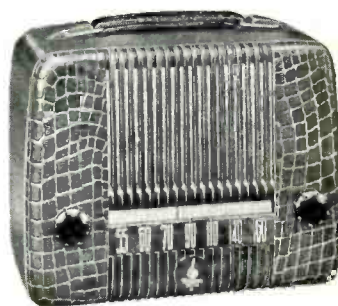

**EMERSON 3-WAY PORTABLE  
Model 568**

**29<sup>95</sup>** *less battery pack*

Amazing sensitivity—power to spare—gets more stations. Economical to operate. Long-lasting single battery pack. In maroon, sand or tan. Cabinet with basket-weave grille.



**EMERSON SELF-POWERED  
PERSONAL PORTABLE  
Model 558**

**24<sup>95</sup>** *complete with batteries*

A handful of radio...packed with power. Automatic lid-operated switch. Sensitive superheterodyne circuit—low battery drain. In beautiful green or ivory plastic, gold-colored hardware.

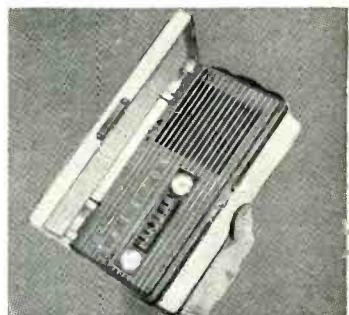

**More People Ask For — More People Buy Emerson Portables**

**EMERSON RADIO & PHONOGRAPH CORPORATION • NEW YORK II, N. Y.**



From Electronics Park...

# 4 NEW KING SIZE



**MODEL 806**—Here is a television dollar stretcher that puts sensational G-E Daylight Television within the easy reach of your customers at a surprisingly low price. It has everything to win friends and quick sales! 10-inch direct-view tube—all U. S. Channels—handsome mahogany finish cabinet. **\$279.95\***

*\*Tax and installation extra, all models. Prices slightly higher West and South, subject to change without notice.*



**MODEL 807**—Some prefer blonds—cabinets, that is—and here is a beauty that is styled and priced for instant favor of smart television buyers! G-E Daylight Television. 10-inch direct-view tube—all U. S. channels. Distinctive cabinet in genuine native American oak veneer. **\$289.95\***



## DAYLIGHT TELEVISION

AT LEAST **80% BRIGHTER**

than ordinary television under the same conditions. The new kind of television bright enough to provide peak picture enjoyment under the ideal seeing condition of normal room lighting!



**MODEL 809**—Now your customers can enjoy the thrill of owning a G-E Daylight Television Console at little more than table model cost! 10-inch direct-view tube—all U. S. channels. Stunning cabinet, paneled in genuine mahogany veneer. **\$329.95\***

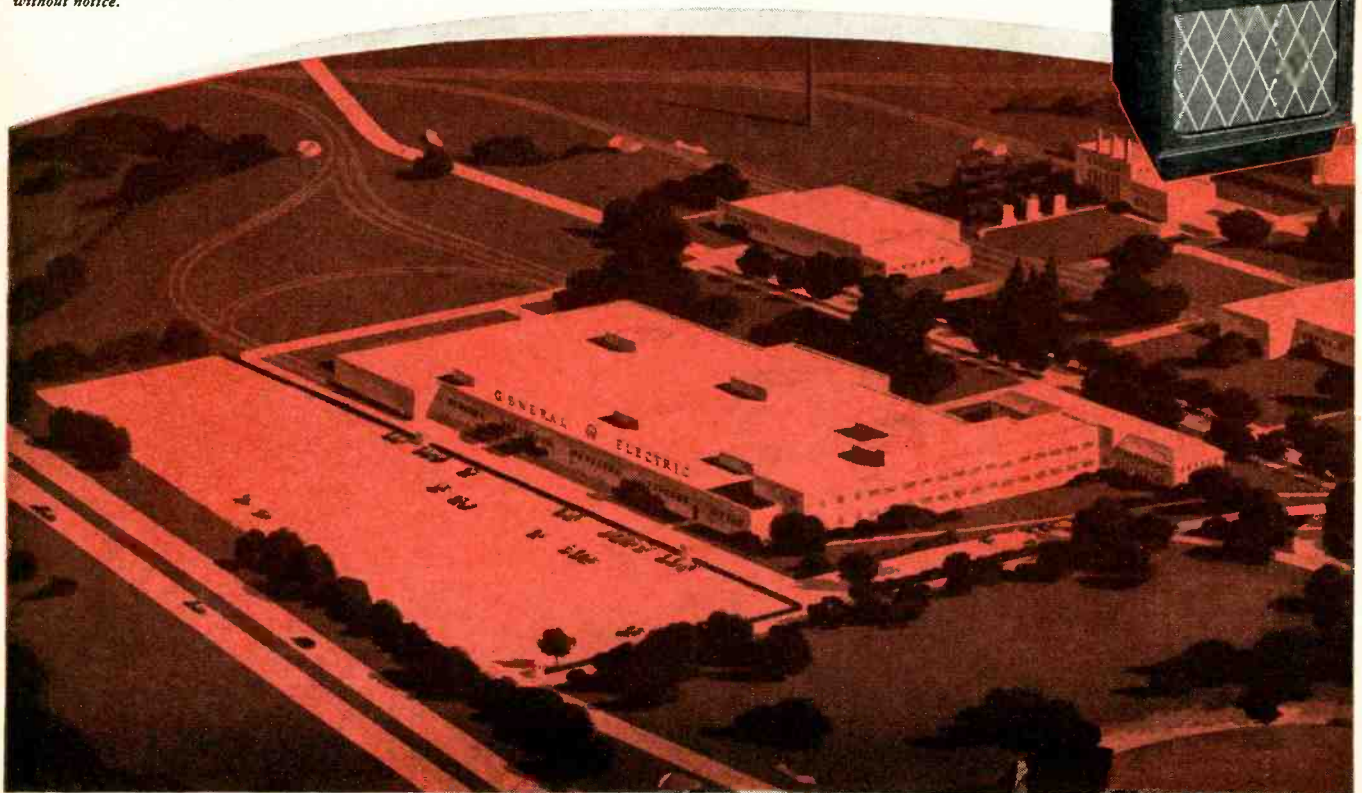

# VALUES FROM \$239<sup>95\*</sup>

## LOWER PRICES—UNMATCHED FEATURES FOR THE BIGGEST VOLUME MARKET IN HISTORY!

EVERY one of these value-packed models is a high-powered sales maker! Each one carries a price tag that calls for immediate and vigorous sales action! No more waiting for lower priced television—it's here! No more waiting for clearer, better, brighter television—it's here! . . .

here in a range of low-priced G-E models that will enable you to cash in on television's greatest year. It's the Bright Line for *king size* profits in '49. Call your General Electric Television distributor today or write to *General Electric Company, Electronics Park, Syracuse, New York.*

*You can put your confidence in—*

GENERAL  ELECTRIC

**MODEL 805**—General Electric Television at an amazing new low price! A quality performer with a dollar sign that will direct traffic to your store! 10-inch picture tube—all U. S. channels—compact cabinet of moulded rich rosewood plastic styled in the modern manner. **\$239.95\***



PERFORMANCE-ENGINEERED  
at the World Center  
of Electronic Progress



# FADA

# FOR

**YES, without  
compromise — FADA  
leadership is firmly  
entrenched with this  
Peerless 1949 Radio and  
Television Line.**



MODEL P111 . . . Tri-  
Powered AC - DC Battery  
Personal Portables . . .  
Standard Broadcast . . . in  
brilliant Ebony, Maroon  
and Genuine Ivory Plastic  
Cabinets . . .

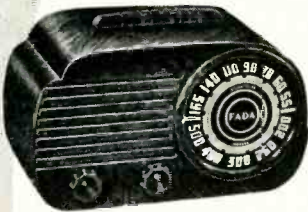

MODEL 845 . . . Six  
tube AC-DC Superhet-  
erodyne Table Model  
Receiver . . . Standard  
Broadcast . . . in  
choice of five exquisite  
colored plastic cabi-  
nets.

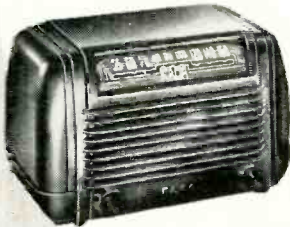

MODEL 830 . . . Five  
tube AC-DC Superhet-  
erodyne Table Model  
Receiver . . . Standard  
Broadcast . . . in Ma-  
roon, Walnut or Genu-  
ine Ivory Plastic  
Cabinets.

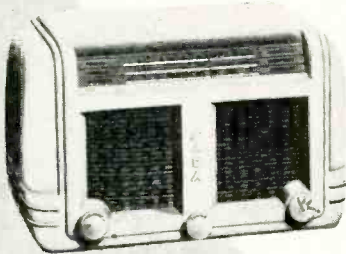

MODEL 777 . . . Five  
tube AC-DC Superhet-  
erodyne Table Model  
Receiver . . . three  
bands, Standard Broad-  
cast Band, Tropical  
Band and International  
Short Wave Band . . .  
Walnut or Genuine  
Ivory Plastic Cabinets.



MODEL 790 . . . Fre-  
quency Modulation at  
its best! Nine tube AC-  
DC Superheterodyne  
Table Model Receivers.  
. . . AM and FM . . .  
in rich Genuine Ivory  
or Walnut Plastic Cab-  
inets . . .

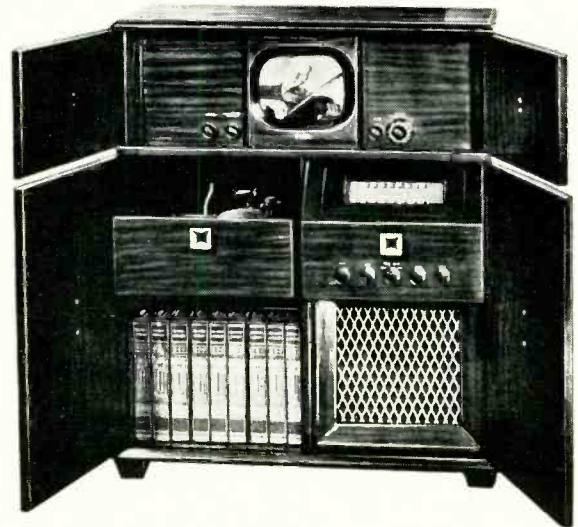

Model 895 . . . 12 1/2" direct view . . . Combination Console  
Television. . . 43 Tubes, AM-FM Radio and DeLuxe Two Speed  
Automatic Record Player with special provision for 45 R.P.M.  
. . . Concert Grand Speaker . . . Genuine Mahogany veneer  
with Crotch Mahogany veneer door panels.

Model 855 . . . Five  
tube AC-DC Superhet-  
erodyne Table Model  
Receiver . . . Standard  
Broadcast . . . in Ma-  
roon, Genuine Ivory or  
Walnut Plastic Cab-  
inets. . . .

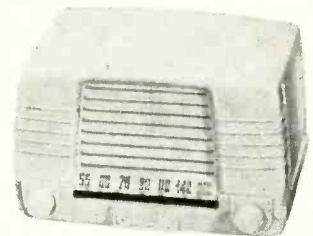

**FADA RADIO & ELECTRIC**

# LEADERSHIP!

## 1949

MODEL 880 . . . 19 1/2 INCH  
Picture Screen . . . Projection  
Television Console in luxurious  
hand-rubbed genuine Mahogany or  
Genuine Bleached Blonde Mahog-  
any veneer.

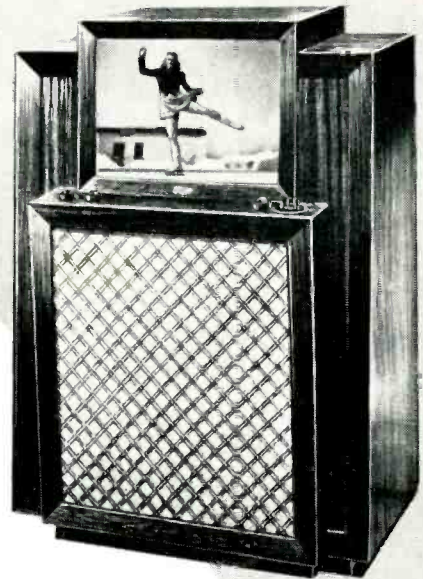

*Incomparable!*

- DESIGN
- PERFORMANCE
- COLOR
- QUALITY
- VARIETY
- LOW PRICE

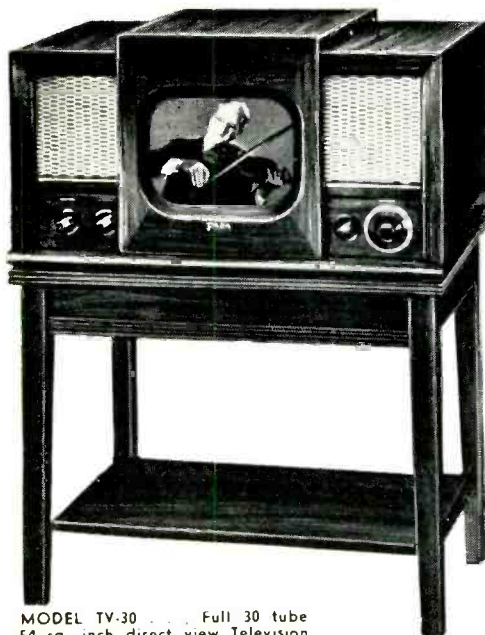

MODEL TV-30 . . . Full 30 tube  
54 sq. inch direct view Television  
Table Model Receiver . . . Ex-  
quisite genuine Mahogany, Walnut,  
Bleached Blonde Mahogany or  
Limed Oak veneer.

MODEL 930 . . . 12 1/2 Inch Tube  
direct view Table Model Televi-  
sion Receiver . . . Beautiful Genu-  
ine Mahogany, Walnut, Bleached  
Blonde Mahogany or Limed Oak  
veneer. . . . 30 tubes.



MODEL 925 . . . 16 Inch Tube  
direct view Table Model Televi-  
sion Receiver . . . Gorgeous hand-  
rubbed Genuine Mahogany, Wal-  
nut, Bleached Blonde Mahogany  
or Limed Oak veneer . . . Model  
G925 same model as above with  
15 1/2 inch Direct view glass picture  
tube. . . . 31 tubes.

Matching Tables as shown above  
are available in all finishes, in  
all models.

*"Pioneers in Radio and Electronics Since 1920"*

COMPANY INC.

BELLEVILLE, NEW JERSEY

"Got a NEW friend for YOU!"



The cream of the "cash" market has been lapped up. It's a cat-fight for what's left of it. Now it's the "time-payment" buyer that offers you the greatest possibilities for volume sales and profit.

There are more than thirty-three million wired homes in the country. At a conservative estimate, their owners and tenants figure to buy more than ten million appliances in 1949, with probably special interest in television, laundry equipment and refrigeration.

Your share of this market is waiting now to be sold . . . and your Commercial Credit representative can help you get it.

He is a sales-minded expert on time-payment financing. It will pay you to consult him.

## COMMERCIAL CREDIT CORPORATION

A Subsidiary of  
Commercial Credit Company, Baltimore • Capital and Surplus \$95,000,000

MORE THAN 300 OFFICES IN PRINCIPAL CITIES OF THE UNITED STATES AND CANADA



# ACCLAIMED

# FOR PRICE • FOR PERFORMANCE

# Tele-tone's *New!* Television



TV-208



**\$149<sup>95</sup>**  
plus \$1.30 excise tax

## Tele-tone

### Portable Television with Built in "Roto-V" Aerial

- The **ONLY** portable with built-in aerial . . . recedes into set when not in use.
- Weighs only 26 lbs. Plays wherever AC current is available.
- It's the **LOWEST PRICED, HIGHEST QUALITY** portable on the market.

Every model a leader in the field! Every price under the market! Every feature the very latest in television engineering . . . including the amazing "picture-lock" for image steadiness and the new "super-sensitive tuner" for greater range, greater power! Tie-in with Tele-tone and you tie-in with the fastest moving radio and television line in the industry.

## Tele-tone Console with oversize 12½" screen

The best in EXTRA LARGE picture performance . . . at the **LOWEST PRICE** on the market. Designed of beautiful mahogany veneers. Cabinet doors close giving it a fine-furniture look. Compare its beauty . . . its perfect image reception.



TV-282

**\$349<sup>95</sup>**  
plus \$1.95 excise tax  
installation extra

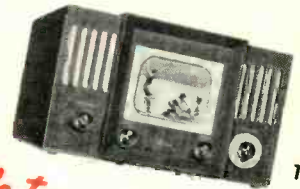

TV-149

## Tele-tone 7" Table Model

The set that made history as a traffic builder . . . sales builder. Low Priced. Crystal clear reception. Hand-rubbed mahogany veneer cabinet handsomely styled to fit any room decor.

**\$169.95\***

Also available in AC-DC, model TV-170 . . . \$179.95\*

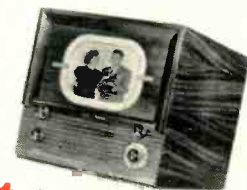

TV-249

## Tele-tone 10" Table Model

The outstanding leader in big screen television. 52 square inches of clear, sharp, steady picture. Furniture styled cabinet of hand-rubbed mahogany veneers. The set for sure-fire profits.

**\$249.95\***

Also available in blonde wood, model TV-259 \$259.95\*  
\* plus excise tax and installation

# Tele-tone RADIO CORPORATION

540 WEST 58TH. STREET • NEW YORK, 19, N. Y.



Tele-tone Model #195

The set that rocked the industry. Full tube, powerful superheterodyne circuit. Permanent magnet Alnico speaker. In ebony polystyrene . . . **\$9.95**  
In ivory polystyrene . . . **\$11.95**



Tele-tone Model #205

A powerful 5 tube superheterodyne set in handsome walnut polystyrene cabinet. With built in loop antenna and permanent magnet Alnico speaker . . . **\$12.95**. In ivory, sand or maroon with carrying handle, model #215 . . . **\$14.95**



Tele-tone Model #214

A 5 tube 3-way portable. Plays on AC or DC current or on self-contained batteries. In ebony polystyrene . . . **\$19.95**. Model #190 in maroon and model #200 in sand . . . **\$22.95**

# FOR A PERMANENT INSTALLATION



\$ **44**<sup>.95</sup>  
LIST

*Use*

## THE NICHOLAS MOTOR FOR ANY TV ANTENNA!

### COMPARE THESE FEATURES

- ★ **Guaranteed** motor and reducing gears totally enclosed in strong **cast aluminum** case.
- ★ **Rustproof Ball Bearings** on output shaft for smooth effortless operation without jerking—never requires lubrication.
- ★ Built on sturdy **cast aluminum** frame. Cannot warp or rust.
- ★ Dependable efficient chain drive to output shaft.
- ★ Simple—a child can operate this device without harming it.
- ★ 370° rotation in 1½ minutes. Instantly reversible at any point.
- ★ Takes any antenna post or mast up to 1¾" diameter, mounts with simple clamps and bolts furnished.
- ★ **Nothing else to buy.** Only four connections to make. Comes **complete** with 60 ft. control wire and all controls, just plug into 60 cycle 105-125 volt light socket.
- ★ Beautiful plastic control case with fingertip operating switch.
- ★ Foolproof—can be stalled indefinitely.
- ★ Pilot circuit always on line. Keeps motor warm, resists ice and snow.

Manufactured by **NICHOLAS EQUIPMENT COMPANY, Bellevue, Ohio**

After 10 million phonographs~  
After 1 billion records...

## Comes the new RCA VICTOR system of recorded music

CONGRATULATIONS to our associates, the RCA Victor Dealers everywhere, whose confidence in RCA Victor has made possible this 50-year marketing achievement.

To them must go much of the praise for these two newest and finest examples of research and engineering—the best automatic changer ever built—the finest record ever made. For, without the assurance of its dealers' confidence, no company could undertake *any* major improvement in home entertainment.

Without the confidence of its dealers in 1923, RCA Victor, founder of the phonograph and record business, could never have started radio down its billion-dollar road. Countless other improvements could never have reached the market if it were not for the great confidence RCA Victor dealers have in RCA Victor products. Include television! Here is a 50-million dollar RCA investment which is today establishing itself as another billion-dollar business for dealers across the country.

And, what inspires this great dealer confidence? Many things . . . too many to enumerate here. But, proof that it is worth having, lies in the fact that today the RCA Victor dealer franchise is the most profitable in the entire industry. With the continued confidence of dealers and with the unique foresight of RCA Victor management, an RCA Victor franchise *will remain* the most profitable in the entire industry.

The new RCA Victor system of recorded music is a shining example of management's foresight. With continued dealer confidence the ultimate profit is inevitable. Work started on the new system in 1939. RCA Victor engineers were granted complete freedom of action . . . freedom from even the major inhibitions, such as non-standardization of record sizes, and speed of turntables. Engineers had but a goal . . . to produce the finest changer and record ever conceived.

The customers' dollars will prove that these engineers reached their goal. The new RCA Victor record and changer constitute the sensible, modern, inexpensive way to enjoy recorded music. The product is ready . . . the public is ready. A demonstration, more than ever before, means a "close." Its advantages will eventually make it the only way to play music in the home.

Meanwhile, RCA Victor will continue to provide its dealers with 78 rpm records and record playing equipment. This period is not one of revolution but one of transition. There will be plenty of time for all dealers to adjust their inventories in making way for this new, improved, more profitable product.

To welcome change is to show a keen awareness of the principal factor lying behind all of our country's industrial progress. That factor is *the constant striving of the American public to own something finer*. In this light, the new RCA Victor system of recorded music will flourish. To RCA Victor's dealers, whose confidence makes such progress possible, will again go a rich reward of bigger profits through continued high turnover.



# DESIGNED FOR

## THE PLAYER . . .

Read  
the new  
RCA-VICTOR  
PLAYER  
story in  
30 seconds !



**World's fastest  
record  
changer!—**

**Trigger-action speed!** Can play more than 50 minutes of music without need of attention. And it's just the music the listener wants when he wants it. It can play up to ten records with speedy, silent, hardly noticeable changes.



**Silent, Record-saving Pickup!—**

The new RCA Victor player exerts a stylus pressure of only 5 grams. There's a new "Silent Sapphire" Pickup. No needle changing. Records sound better—last longer. Two vital customer "wants."



**Compact and light!—**

The changer unit occupies less than half the space of other types. This opens entirely new avenues to smarter console cabinet styling . . . to greater economies and greater values. The lightweight, compact table phonograph model can easily be carried from room to room.



**Big Pylon Spindle  
holds changer mechanism!—**

Changer mechanism is within the large spindle. No posts or clamps to adjust. Fewer moving parts—*it's trouble-free.* The new RCA Victor changer is the surest, easiest operating changer ever designed.

### **4 QUICK INSTRUMENT FACTS TO TELL YOUR CUSTOMERS**

1. World's fastest changer.
2. Easiest, surest operating changer ever...and it costs less.
3. Automatic . . . load the spindle —press a button once and that's all.
4. Can play more than 50 minutes without need of attention.

# EACH OTHER

## ... THE RECORD



POPULAR ... (Black)



CLASSICAL ... (Red)



POPULAR CLASSICAL ... (Midnight Blue)



CHILDREN'S ... (Yellow)



COUNTRY AND WESTERN ... (Green)



BLUES AND RHYTHM ... (Cerise)



INTERNATIONAL ... (Sky Blue)

Just a fast 30 seconds for the new RCA-VICTOR Record Story!

### Distortion-free playing surface!—

Theoretically, every record can have a "Quality Zone"... a portion of the record in which no distortion occurs. Music recorded beyond this zone is distorted. New RCA Victor records are the first to be recorded entirely in the "Quality Zone"—and they play as long as ordinary 12-inch records.



### Lasts many times longer!—

Made of non-breakable vinyl plastic with a special "Shoulder Construction," the new record lasts up to 10 times longer... cuts inventory losses due to damage in handling and storing. The surface-saving shoulder keeps playing surfaces from rubbing one another... prevents damage to record grooves.

### Convenient 7-inch size!—

More than 150 single records or 18 symphonies fit in one foot of bookshelf space. No storage problems for your customers. You can display a wider, more complete selection without sacrifice of space.



### Low Cost Creates Bigger Market!—

From the record press to the customer's purse, the 7-inch record costs less... opens a bigger market... new collectors! And those who own ordinary records now find that it takes less money to buy more pleasure. The new 7-inch record ensures you greater profit through faster turnover.

**Sparkling identifying colors!—** Record classification is simplified because a different color is used on the entire record... not just on the label to denote each classification. This helps you to determine the type of record at a mere glance.

### 4 QUICK RECORD FACTS TO TELL YOUR CUSTOMERS

1. This is the first record to be distortion-free over its entire playing surface.
2. No storage problems... records fit ordinary bookshelf.
3. Non-breakable... made of vinyl plastic with surface-saving shoulder... lasts many times longer.
4. Low cost... only 7 inches... yet can play as long as ordinary 12-inch record.



# Greater Variety for Greater Sales!

... you can offer your customers the new RCA Victor system in their choice of 7 magnificent instruments... all (except the attachment, of course) with the exclusive RCA Victor "Golden Throat" tone system.



**Model 9TW333**—52-square-inch RCA Victor Eye Witness Television, FM-AM radio. 78 rpm automatic changer for 10- and 12-inch records, plus the new RCA Victor system of recorded music. Walnut, mahogany or blond finished cabinet with generous storage space for 7-inch records.

**Model 9EY3**—Smartly styled, compact RCA Victor Player in a rich maroon plastic cabinet with distinctive, gold-colored trim. Here is a complete phonograph to offer your customers the advantages of this new system at an amazingly low price.



## THE MUSIC YOUR CUSTOMERS WANT IS ON THE NEW RCA VICTOR 45 RPM RECORDS

The Music Your Customers Love Best, by their favorite artists, is on the new RCA Victor records. This list is but a small sampling to give you an idea of the variety available in the introductory library. Additional standard top-selling favorites and current releases will be added regularly.

### RED SEAL ALBUMS

- BOLERO (Ravel)—Boston Symph. Orch., Serge Koussevitzky, Cond. WDM-1220
- CONCERTO No. 1, IN B-FLAT MINOR, Op. 23 (Tchaikovsky)—Artur Rabinstein, Pianist, with the Minneapolis Symph. Orch., Dimitri Mitropoulos, Cond. WDM-1159
- PIANO MUSIC OF MENDELSSOHN—Vladimir Horowitz, Pianist WDM-1121
- ROMEO AND JULIET (Overture-Fantasia) (Tchaikovsky) WDM-1178
- COLAS BREUGNON: OVERTURE, Op. 24 (Kasalevsky) (final side)—Arturo Toscanini and the NBC Symph. Orch. WDM-1178
- SLEEPING BEAUTY, THE (Music from the Ballet) (Tchaikovsky)—Leopold Stokowski and his Symph. Orch. WDM-1205

### RED SEAL SINGLES

- AH! SWEET MYSTERY OF LIFE (Young-Herbert) INDIAN LOVE CALL — (Harbach-Hammerstein II-Friml)—Jeanette MacDonald, Sop., and Nelson Eddy, Bar., with Nathaniel Shilkret and Orch. 49-0200
- AUFENTHALT (Schubert) AVE MARIA (Schubert)—Marian Anderson, Contr., with Franz Rupp at the Piano 49-0136
- BECAUSE (Tschemacher-d'Hardelot) BLUEBIRD OF HAPPINESS (Heyman-Davies-Harmati)—Jan Peerce, Ten., with the RCA Victor Orch., Sylan Levin, Cond. 49-0135
- CARMEN FANTASIE (Based on themes from Bizet's "Carmen") (Waxman)—Jascha Heifetz, Violinist, with the RCA Victor Orch., Donald Voorhees, Cond. 49-0130
- HUNGARIAN RHAPSODY No. 2, IN C SHARP (Liszt)—Alexander Brailowsky, Pianist 49-0262

### COUNTRY AND WESTERN

- ALL-TIME HITS FROM THE HILLS—Eddy Arnold, The Tennessee Plowboy, and his Guitar WP-195
- MY HEART WENT THAT-A-WAY NO CHILDREN ALLOWED—Roy Rogers, Voc., with Country Washburne and his Orch. 48-0028
- ROOTIE TOOTIE (V.R.) TENNESSEE WALTZ (V.R.)—Pee Wee King and his Golden West Cowboys 48-0003

### MUSICAL SMART SETS

- DOWN MEMORY LANE—Vaughn Monroe and his Orch. WP-202
- THEME SONGS—Tommy Dorsey, Tex Beneke; Freddy Martin; Vaughn Monroe; Wayne King; The Three Suns; Sammy Kaye, Larry Green WP-217
- YOU AND THE NIGHT AND THE MUSIC—Tony Martin, Voc., with Earle Hagen and his Orch. WP-203

### POP CLASSICS

- STUDENT PRINCE, THE (Donnelly-Romberg)—Al Goodman and his Orch.; Mary Martha Briney and Frances Greer, Sopranos; Donald Dame, Ten.; Earl Wrightson, Bar., with The Guild Choristers WK-8

### POPULAR SINGLES

- ALICE BLUE GOWN—Waltz SMOKE GETS IN YOUR EYES—Waltz—Wayne King and his Orch. 47-2718
- BECAUSE IF YOU HAD ALL THE WORLD AND ITS GOLD Perry Como, Voc., with Russ Case and his Orch. 47-2728
- DANCING TAMBOURINE STUMBLING—The Three Suns, Instrumentalists 47-2756



**Model 9JY**—Easily attached to any make set, this fully automatic new RCA Victor Player brings your customers the new distortion-free recordings—50-minute programs without need of attention—at a new low price!



**Model 9W101**—Superb FM-AM radio... and the new RCA Victor system of recorded music. Rich traditional cabinet of attractive walnut or lovely mahogany finish. Storage for 216 singles or 24 albums... more than 38 hours of this great new listening pleasure.



**Model 9Y7**—The most amazing table combination ever offered. Imagine... an automatic record changer... powerful Standard Band radio plus storage space for as many as 60 playing sides—all in one compact table model. Finished in walnut, mahogany or blond.



**Model 9W105**—A console with AM and static-free FM radio with a powerful 12-inch speaker... 78 rpm record changer plus the new RCA Victor system of recorded music. Mahogany, walnut or blond finished cabinet has ample storage for records... 7-, 10- and 12-inch.



**Model 9W103**—FM and AM radio, a big 12-inch speaker, plus the exciting new RCA Victor system of recorded music. Beautifully finished in lined oak, walnut or mahogany, the cabinet stores 33 hours of recorded music—189 singles or 24 of the new albums.

The new RCA Victor system is the modern, inexpensive way to enjoy recorded music. It offers more advantages and enjoyment than does any other type of record or record playing equipment. The advantages start with low cost and run a course of conveniences never before

heard of. The enjoyment starts with a distortion-free record and continues with exactly the music your customers want when they want it. This combination of advantages and enjoyment has been calculated to best suit the desires of the greatest number of your customers.



# RCA VICTOR

DIVISION OF RADIO CORPORATION OF AMERICA

"Victrola"—U. M. Reg. U. S. Pat. Off.

ONLY RCA VICTOR MAKES THE VICTROLA

# Everybody wants tape recorders!



**MUSICIANS WANT 'EM** — Tape reproduces a greater range of tones with higher fidelity than any other recording medium. Performances on tape give singers and instrumentalists an absolutely lifelike reproduction of their efforts.



**EDUCATORS WANT 'EM** — Speech and language classes, drama and music classes all benefit from this new recording medium. Recorded performances by individuals and groups mean faster learning, easier criticism.



**DOCTORS WANT 'EM** — Recordings made on tape during examinations give doctors an invaluable reference file, make it easy to chart the patient's progress. Professional people find tape ideal for rehearsing speeches, sermons, lectures.



**PARENTS WANT 'EM** — Junior's first words, cute sayings, birthday speeches make up a priceless album of recordings on tape. Annual recordings of voices, instrumental renditions, school recitations are invaluable in later years.

## Here are some of the features tape recording offers your customers:

1. Uninterrupted half-hour or hour-long concerts
2. Matchless fidelity of tone
3. Low-cost operation . . . reels of tape can be erased and re-used indefinitely
4. Freedom from needle scratch, distortion, crosstalk, snarls and backlashes

5. Unlimited playbacks with no loss of tone

Now's the time to make your store headquarters for tape recording. For complete details about what tape recording can do for your business, write today to Dept. RT49, Minnesota Mining & Mfg. Co., St. Paul 6, Minn.

ANOTHER **3M** COMPANY PRODUCT

MINNESOTA MINING & MFG. CO., St. Paul 6, Minn.

Makers of "SCOTCH" Brand pressure-sensitive tapes, "3M" abrasives, adhesives, and a wide variety of other products for home and industry.

General Export: DUREX ABRASIVES CORP., New Rochelle, N. Y.  
in Canada: CANADIAN DUREX ABRASIVES LTD., Brantford, Ontario



REG. U.S. PAT. OFF.  
**SCOTCH**  
BRAND  
Sound Recording  
Tape

*a*

*sensation*

## NEW SPARTON TV-RADIO- PHONOGRAPH COMBINATION



to keep Sparton dealers ahead  
in a price-conscious market!

ONLY

**\$399<sup>95</sup>**

*featuring*

- ★ Direct-view television!
- ★ AM radio reception!
- ★ Static-free FM!
- ★ Sparton single-arm,  
dual-speed record  
changer!

(Plays long-playing and standard records)

... PLUS Sparton's exclusive Automatic Brightness Control ... a large 10-inch picture tube with 54-square-inch viewing area ... 28 tubes, including 4 dual-purpose tubes (32-tube performance) ... fewer controls, yet easier tuning ... a 10-inch permanent-magnet speaker ... and a beautiful hand-rubbed mahogany finish!

YES ... check that price tag against a buyer's market that's in a "show me" mood. Here's a honey that will sweep the town ... Best yet, it's yours, as a Sparton dealer, to feature *exclusively* in your community under the SCMP—the Sparton Cooperative Merchandising Plan. If you are not a Sparton dealer, better write *now* to see whether the Sparton franchise is still available in your town.

*Sparton*  
Radio-Television's Richest Franchise

SPARTON RADIO-TELEVISION

Division of

THE SPARKS-WITHINGTON COMPANY  
JACKSON, MICHIGAN



# easier, faster TV sales in D.C. areas with C-D Converters



**CORNELL-DUBILIER**  
 world's leading manufacturer of  
**CAPACITORS**  
**VIBRATORS • CONVERTERS**



Input Volts: 110 V.D.C.; Output Volts: 110 V.A.C.; Watts Cont.: 150 W.; Watts Int.: 250 W.; Variable Frequency Control

- easily installed on all types of TV sets
- simple design eliminates lubrication and other mechanical maintenance
- quiet, more efficient service at lowest cost
- a complete line to meet all needs

For further details write to  
 Cornell-Dubilier Electric Corporation,  
 Dept. RT-49, South Plainfield, New Jersey  
 Other large plants in  
 New Bedford, Worcester, and Brookline, Mass.;  
 Providence, R. I., and Indianapolis, Ind.

# Admiral



*America's Smart Set*

**All Admiral Radio-Phonographs (from  
Combinations (from \$399.95 and up)  
"Triple-Play" automatic record changer**

# sensational new

# "triple-play"

## Automatic record changer

PLAYS ALL RECORDS...ALL SIZES...ALL AUTOMATICALLY

78 RPM STANDARD

33 1/3 RPM LONG PLAY

45 RPM



**NOW! ONE FOR ALL . . .** Admiral leads again with *one for all . . .* in a sensational new "triple-play" record changer that plays all records . . . all sizes . . . and all automatically.

Popularity of all the new LP records is growing by leaps and bounds. They are being backed by the strongest record promotion campaigns in years. Your customers will want to play both the 33 1/3 and 45 RPM records . . . and because most of them have extensive 78 RPM libraries, they will want to play those, too!

There is only one answer . . . a dependable, easy-to-operate instrument that plays them all . . . and Admiral has it! Admiral's new "triple-play" changer plays 78 RPM, 33 1/3 RPM and 45 RPM records . . . all sizes . . . all automatically. *Any record changer that fails to do as much is obsolete!*

**ONE TONE ARM PLAYS ALL!** You don't need an extra record player with the new Admiral . . . one instrument plays all records. Furthermore, the Admiral "triple-play" changer does away with extra tone arms . . . just one tone arm plays *all* records. Plays up to 12 records automatically with one loading. (Twelve 45 RPM records, for example, not merely eight.)

Two long-life, high fidelity needles are provided . . . one for standard records, the other for LP Microgroove records. Control switch at head of tone arm brings proper needle instantly into play. Click . . . and it's there!

**THREE INTERCHANGEABLE CENTER POSTS.** Three interchangeable center posts for automatic playing of all records. Take one out . . . slip another in its place . . . two seconds and it's done! Special receptacles provided on all consoles for center posts not in use.

Admiral's sensational new "triple-play" record changer is available exclusively on all Admiral radio-phonographs and television combinations. It's another big plus feature that's been added to the hottest line in the world today. Admiral Corporation, Chicago 47, Ill.—World's Largest Manufacturer of Automatic Phonographs.

**SEE! HEAR! ON NBC TELEVISION! ADMIRAL "BROADWAY REVUE" EVERY FRIDAY, 8 TO 9 PM, EST**

**\$69.95 and up) and all Admiral Television are now equipped with sensational new at no extra cost.**

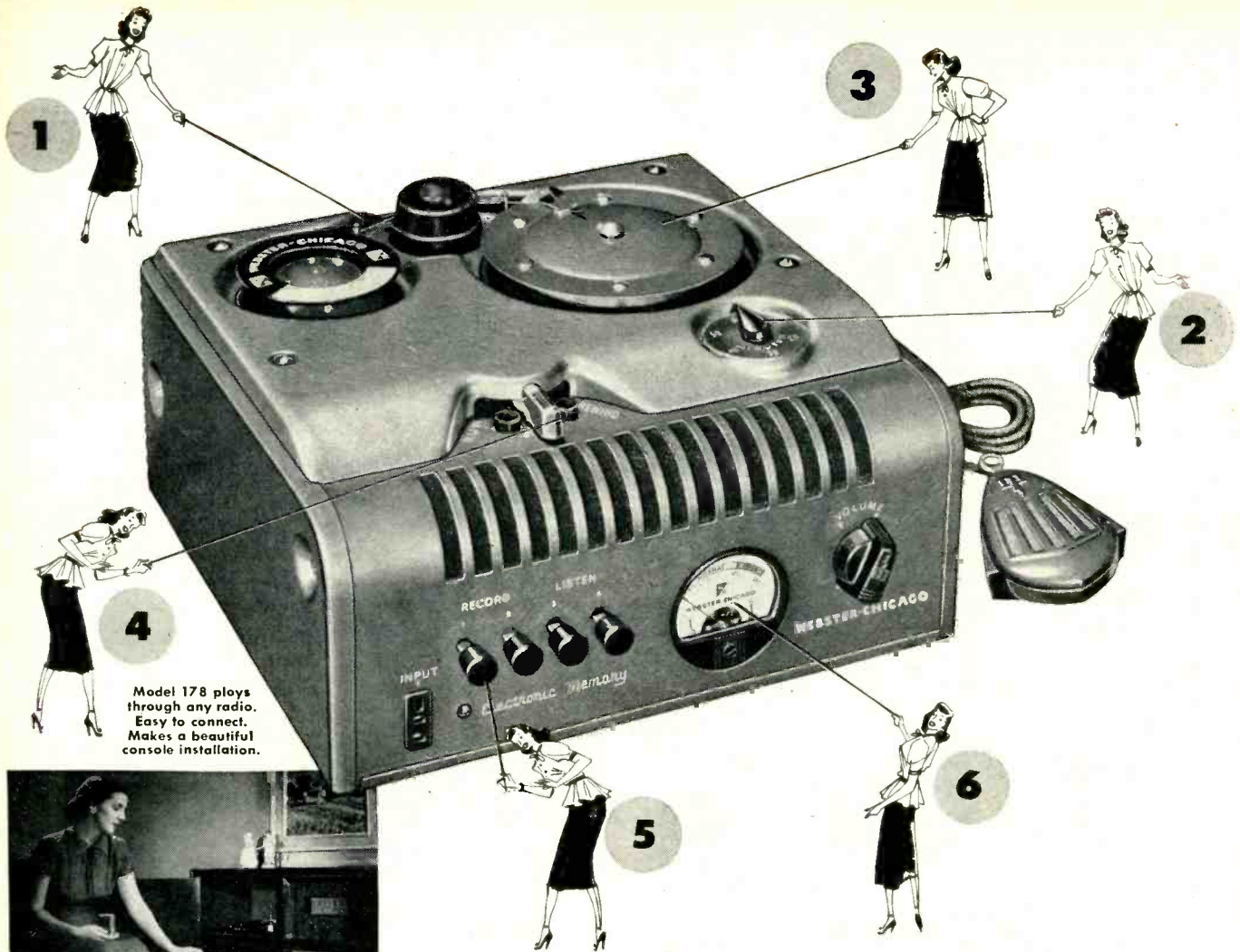

Model 178 plays through any radio. Easy to connect. Makes a beautiful console installation.



## HERE'S A WIRE RECORDER

*you can sell!* Transforms Any Radio Into a Wire Recorder Combination

Webster-Chicago *Electronic Memory* Wire Recorder Model 178 is packed with features that make it the top buy of the year for your customers—the top profit item of the year for you.

1. Automatic Stops—in both directions as the end of the wire is reached.
2. Elapsed Time Indicator for accurate location of a recording or any portion of it.
3. Removable Take-up Drum for recordings of longer than one hour.
4. Lockfast Operating Lever secures in "run", "stop" or "rewind"—releases with light finger pressure.
5. Push-button selection of "record-listen" combinations is easy to use.
6. Meter-type Recording Volume Level Indicator for accurate recording results.

These are the features that thousands of prospective wire recorder users are looking for.

Model 178 gives them all these at an amazingly low cost. It is easy to sell.

Model 178 has Underwriters' Laboratories approval for your protection and increased sales.

CALL YOUR WEBSTER-CHICAGO DISTRIBUTOR

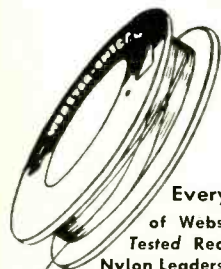

Every New Spool of Webster-Chicago Pre-Tested Recording Wire has Nylon Leaders attached for:

- Easy Threading
- Perfect Level Wind
- Activating Automatic stops on W. C. Wire Recorders
- Preventing Wire from running off the spool
- Easy handling

These features make Webster-Chicago Recording Wire the best buy for wire recorder users who want the finest results.

Tell your customers about Nylon Leaders—and see your Webster-Chicago Distributor about stock.



# WEBSTER-CHICAGO

5610 W. Bloomingdale Avenue, Chicago 26, Illinois

Sharpen a pencil  and prove it yourself!

# Bendix Radio and Television

provides the finest

*Profit  
plan*

**IN THE INDUSTRY**

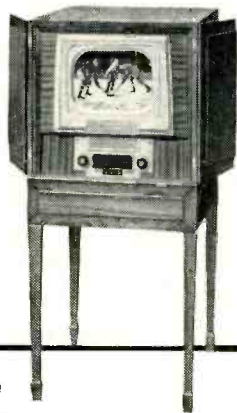

Sell "the Finest Picture  
Money Can Buy"

The only top quality television franchise that allows you to make home demonstrations with the assurance that no competitor can cut the price and ruin the sale.

BE THE EXCLUSIVE BENDIX TELEVISION DEALER IN YOUR COMMUNITY!

### Beats cutthroat competition

How much could you make if you could compete successfully for the 85% of business going to chain stores, discount houses and the like? *You can* with Bendix Radio and Television. Prices are competitive and quality so much finer that customers convince themselves of your superior values.

### Stops seasonal price cuts

How much could you make by avoiding slow-season dumping and price-cuts? *You can* with Bendix Radio and Television. At their low "no middleman" prices, they remain bargains regardless of competitive price cuts—provide the "special offer" to build off-season business.

### Ends "free riding" on your advertising dollar

How much more would your own advertising "pay off" if every buyer it moved to action came to *your* store. That has to happen when you feature Bendix Radio and Television. No dealer down the street can steal your prospects or undercut your advertised prices because your franchise is exclusive to your community.

### Makes you sole beneficiary of factory advertising

How much more could you make if every national radio and television advertisement appearing in your community directed customers only to *your* store? That's exactly what happens with Bendix Radio and Television.

### Exceptionally liberal discounts

Bendix Radio and Television discounts are better than many and equal to any—and, you don't have to give them away in price-cuts and "here's hoping" advertising.

What's the result of all these special franchise features? Year in and year out you can expect a higher net profit with Bendix Radio and Television—the direct-to-dealer plan with the biggest backing in the industry. Get the story now—this franchise is limited to select dealers only.

BENDIX RADIO DIVISION of  
BALTIMORE 4, MARYLAND



**BENDIX RADIO**

REG. U.S. PAT. OFF.

Write for Details of the **Bendix Radio and Television** } Direct-To-Dealer **PLAN!**

CONVERT YOUR CUSTOMERS SETS TO

# GIANT SCREEN



# TELEVISION

AND MAKE A GOOD **PROFIT** DOING IT!



MODEL 712 list price \$12.95  
For 3" and 7" tubes.



MODEL 719 list price \$19.95  
For 7" tubes.



MODEL 1029 list price \$29.95  
For 7" and 10" tubes.



MODEL 1039 list price \$39.95  
For 10" and 12" sets.



MODEL 1059 list price \$59.95  
For 10" and 12" sets.

STAND MODEL 1040 list price \$39.95 For the 7" and 10" tubes.  
STAND MODEL 1050 list price \$49.95 For the 10" and 12" tubes.  
STAND MODEL 1075 list price \$59.95 For the 10" and 12" tubes.

†Prices slightly higher West of the Mississippi

Your customers want the Walco Tele-Vue-Lens — the world's finest T-V screen enlarger! They know it gives giant screen television pictures with no distortion from any viewing angle! Stock, display and demonstrate the most complete line of T-V screen enlargers made! YOU double your profits with TELE-VUE-LENS!

Note to Distributors: Some territories still open. Write for details today.

The Walco TELE-VUE-LENS  
Manufactured and Distributed by  
E. L. COURNAND AND CO., 3835 Ninth Avenue, New York City, N. Y.



WHAT'S IN IT  
FOR ME?

By *Television Mike*

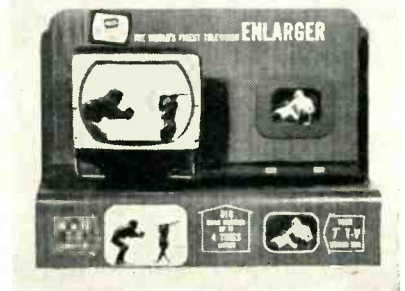

Yes men! Here it is . . . the new Tele-Vue-Lens Merchandiser that does 99% of your selling job for you. Beautiful shadow-box effect stops traffic. Pulls your customers over.

With it, your customers do their own demonstrating and sell themselves! You just wrap up the Tele-Vue-Lens and punch your cash register.

Don't miss this big profitable opportunity to convert your customers' 7", 10", or 12" sets to 16" screen with Walco Tele-Vue-Lens. You can sell a lens to every customer on your list!

This is your opportunity to make a fast dollar and keep your customers happy. Remember! There's no installation, no servicing! Your customers know they'll see a better T-V show with a Walco Tele-Vue-Lens!

Make a profit with no fuss. Write me today. — TELEVISION MIKE, E. L. Cournand & Company, 3835 Ninth Avenue, New York City, New York, and I'll send complete information to you immediately.



Stock these fast-moving types and watch your business grow! VS002; VS013; VS016; VS019; VS036; VS047; VS050.

# Battery Headliners... These 7 RCA Batteries cover more than 80% of your portable type requirements!

Now... you need handle only these seven RCA battery types to meet most of your customers' requirements! Here are seven types that simplify your stocking problems... give you quick turnovers... and a tremendous repeat business.

And... for your special needs... RCA also has the slower-moving and "hard-to-get" types... locally warehoused for quick delivery through your RCA Battery Distributors.

Remember, too... RCA's selective distribution primarily to the RADIO TRADE steers customers back to you for repeat sales.

Build your business with the battery that's radio-

engineered for extra listening hours! The RCA Trade Mark and attractive packaging guarantee immediate customer acceptance!

## Put those Profitable "Portables" right on the Selling Line!

Another RCA First—this compact counter merchandiser sells RCA Batteries on sight. Ask your RCA Battery Distributor about the greatest array of selling aids in battery history... all geared to the Radio Trade.



ALWAYS KEEP IN TOUCH WITH YOUR RCA BATTERY DISTRIBUTOR



**RADIO CORPORATION of AMERICA**

HARRISON, N. J.

**Mr. Dealer:**

**TELE KING**  
gives you **4** profit-making advantages!



**The biggest profit margin**



**Lowest prices in the field**



**Superb precision-built sets**



**Fast mounting volume**



**THE GRAMERCY**

Unequaled walnut or mahogany veneer 10" table model with razor-sharp TELERAMIC picture. All TV channels, automatic "tele-lock."  
**\$229<sup>95</sup>**  
in walnut, plus federal tax.

Only TELEKING offers you the tremendous turnover potential, the roaringest torrent of runaway sales in television history. For TELEKING is the most amazing drawing card in the field. Decorative, powerful precision instruments, priced for a mass market, backed by profit-producing promotion that pushes customers into your store... pre-sold! What more can you possibly want... than more TELEKING?



**THE WILSHIRE**  
Magnificent mahogany 12 1/2" console. Big clean-cut TELERAMIC picture with automatic "tele-lock." All TV channels. New 10" speaker high-fidelity sound.



**THE STUART**  
Stunning mahogany veneer 12 1/2" table model. All TV channels with automatic "tele-lock" to keep the large TELERAMIC picture steady and clear.



**THE REGENT**  
Perfect period console in gorgeous walnut or mahogany, 10" TELERAMIC picture, all TV channels, automatic "tele-lock," high-fidelity 8" speaker

**Tele King**

CORPORATION

Showpiece of the Home

Get in touch with TELE KING today... write, wire, or phone Mr. Profit, Dept. RT4, TeleKing Corp. 601 West 26th St., New York, N. Y.



# THIS DISPLAY REALLY SELLS VUE-SCOPE



## ***This Hard-Hitting Store-Tested Display IS YOURS WITHOUT COST!***

Actual tests in TEN RETAIL STORES prove that this terrific display **DOUBLES** and **TRIPLES** your Vue-Scope sales! This revolving "silent salesman" shows how your *three fastest-selling Vue-Scope Lenses* look and work on the television set—demonstrates the sensational new "Magic-Mount" Bracket. Lenses *sell themselves!* Get yours **NOW!** *Regular Value \$25.00*

**Write Now!** 

*Write us direct or ask your distributor how to get a VUE-SCOPE Television Magnifying Lens Display without charge. Do it TODAY!*

**CELOMAT CORPORATION**

521 West 23rd Street, New York 11, N. Y.

Gentlemen: Yes, I'm interested in hearing more about this sensational new Vue-Scope Display. Please send me complete details!

Name \_\_\_\_\_

Address \_\_\_\_\_

City \_\_\_\_\_ Zone \_\_\_\_\_ State \_\_\_\_\_

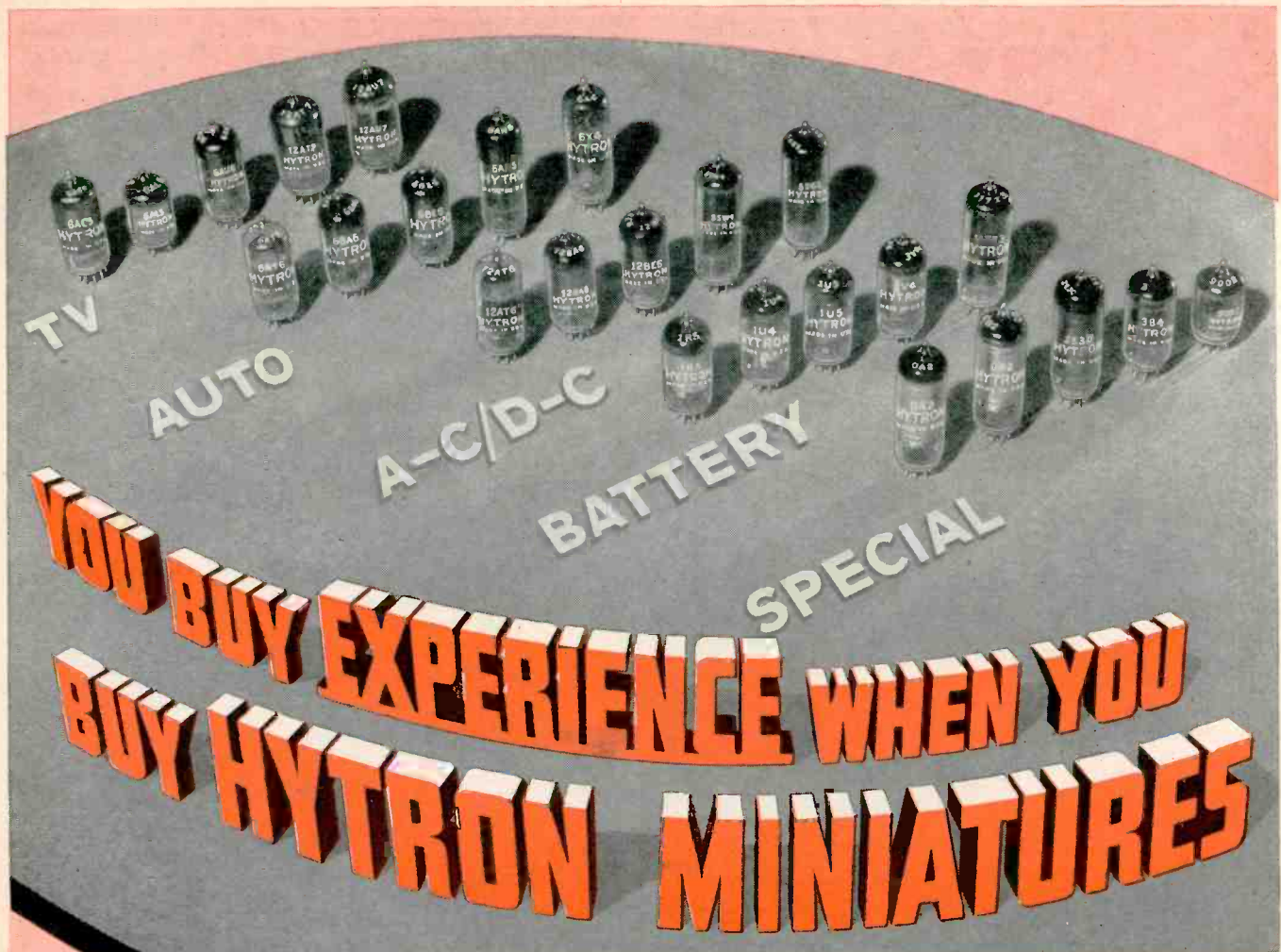

TV  
 AUTO  
 A-C/D-C  
 BATTERY  
 SPECIAL

# YOU BUY EXPERIENCE WHEN YOU BUY HYTRON MINIATURES

AS YOU CAN READILY IMAGINE, these little fellows are tough to make—and make right—because they are so darned tiny. A heck of a lot of *experience* is a must.

Hytron has it. First to telescope standard glass tubes to Bantam GT size. First to originate the subminiature. First to make even subminiatures tinier. First to build the smallest subminiature used in the wartime proximity fuse.

With this background in making 'em *small*, Hytron manufactured millions of wartime miniatures like the 6AK5, 9001, 9002. Quite naturally, it began to originate miniatures too. Some of the more famous: 6AR5, OB2, 2E30. Hytron also originated the first and only Reference Guide (now in its third edition) for *all* miniatures, regardless of make.

Yes, when you buy Hytron miniatures, you buy the most valuable advantage any manufacturer can offer you. *Experience*.

SPECIALISTS IN RADIO RECEIVING TUBES SINCE 1921

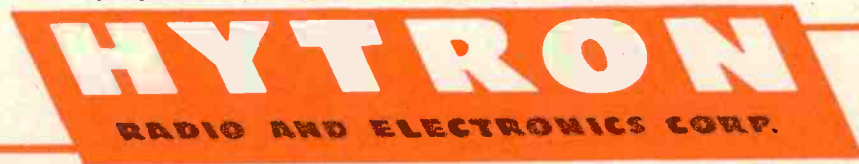

MAIN OFFICE: SALEM, MASSACHUSETTS



# in **PROJECTION TELEVISION**, too RCA VICTOR

is the name your customers ask for most!



**SHARPEST**  
**BLACK and WHITE**  
**PICTURE CONTRAST**  
**EVER**



## Model 8-PCS-41

**THE SET WITH EXTRA FEATURES —**

*and a screen nearly newspaper-page size*

Here is a projection television set you'll find easy to sell. Why? Because this console offers your prospects all the latest styling and engineering developments from RCA Victor . . . because this console gives your customer more value for his television dollars.

When you sell RCA Victor Model 8-PCS-41, you won't have customers complain about yellow or blue images on the screen. The new RCA Victor All-Silicate Face Kinescope in this set gives the sharpest black and white projection television pictures ever.

A famous name with famous features makes the difference. Only when you offer RCA Victor Eye Witness television can you offer all these famous "sell" features: Eye Witness Picture Synchronizer, Automatic Multi-Channel Station Selector, "Golden Throat" Tone System and the RCA Victor Television Owner Contract.

All these convincing sales points make your selling job easier, more profitable. Remember, with RCA Victor you make greater profits through quicker turnover. Yes, in projection television, too, RCA Victor is the name your customers ask for most!



**RCA VICTOR**  

*world leader in radio . . . first in recorded music . . . first in television*

# SMARTEST SELLING IDEA in TV!

Stromberg-Carlson advertising brings it home every month to the 18,000,000 families who read

- LIFE • TIME
- 
- SATURDAY EVENING POST
- 
- HOLIDAY
- 
- BETTER HOMES and GARDENS
- 
- HOUSE and GARDEN
- 
- HOUSE BEAUTIFUL
- 
- NEW YORKER
- 
- NATIONAL GEOGRAPHIC

See  
it  
Better



Hear  
it  
Better

## STROMBERG-CARLSON TELEVISION

*"See it Better.. Hear it Better"*

... with STROMBERG-CARLSON TELEVISION! That is the challenge and the promise *you'll see and hear everywhere* this year! It will support your efforts from the pages of the magazines that have

the most influence on people in your community.

No other manufacturer can live up to such a convincing advertising theme with more authority than STROMBERG-CARLSON, famous for its tradition of fine craftsmanship in radio since 1924 and in video since 1939.

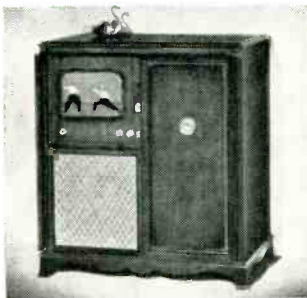

The LANCHESTER  
Television-Radio-Phonograph  
Mahogany

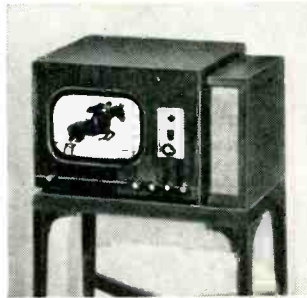

The ROCHESTER  
Television and FM Radio  
Mahogany



The HEPPLEWHITE  
FM-AM Radio-Phonograph  
Mahogany

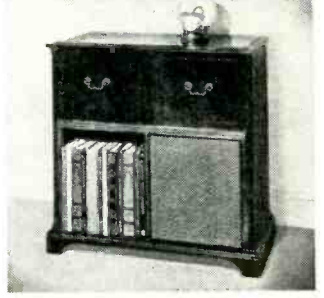

The WINDEMERE  
FM-AM Radio-Phonograph  
Blond or Mahogany

In television, as in radio, there is nothing finer than a

# STROMBERG-CARLSON

Stromberg-Carlson Company, Rochester 3, N. Y. — In Canada, Stromberg-Carlson Co., Ltd., Toronto

# RADIO & TELEVISION RETAILING

*Including Radio and Television Today*

O. H. CALDWELL, Editorial Director



M. CLEMENTS, Publisher

1949!

RMA's 25th YEAR . . . TELEVISION'S 10th YEAR . . . CALDWELL-CLEMENTS' 28th YEAR IN RADIO - TV PUBLISHING

*Watch for RADIO & TELEVISION RETAILING'S 25th Anniversary Issue Next Month*

## Control of U.S. Radio Airwaves Over a Span of Twenty-Five Years

FROM HOOVER, TO CALDWELL, TO COY

In this picture, taken at the Radio Executives Club, New York City, March 10, at center is shown ex-President Herbert Hoover who as Secretary of Commerce in 1921 set up first plans for policing the infant-radio-broadcasting industry through co-operative efforts on the part of the stations. Secretary Hoover and his assistant, Judge Davis, supervised and controlled all radio broadcasting until and through 1926.

In 1927 full authority for all radio wavelengths was given to the Federal Radio Commission, pioneer engineer member of which was Orestes H. Caldwell (left) then as now editor-in-chief of this magazine, Radio Retailing, who took a leading part in the formative reallocations of wavelengths, spectrum planning, and radio policy decisions of 1927-8-9.

Successor to the Radio Commission was the Federal Communications Commission, the present chairman of which, Hon. Wayne Coy, is seen at the right.



# What's Ahead!—in Radio,

**NEWSPAPER ADS DISCUSSING POSSIBLE TV** set obsolescence if and when UHF allocations come, stirring up a hornet's nest in the radio industry. According to the FCC, there is no proposal to drop the present 12 channels, and, furthermore, in viewing the situation, it is a fact that equipment for transmitting in the ultra-high frequency band (500 mc and above) is still in the developmental stage. Although assignments of channels in UHF may be made later on this year, commercial application will have to wait until technical problems have been solved, and such developments may require several years for completion.

**SHORTAGE OF GOOD RETAIL SALESMEN** continues to be a very real problem to dealers who are faced with the necessity for going out after business, both in following up prospects and in canvassing. Some merchants are finding that too many of the new-comers to the salesmanship ranks dislike making evening calls, fear cold canvassing, or get discouraged too easily.

**THE SLOW-UP IN PHONO RECORD SALES** continuing, but those dealers who plan to keep records and plug them for all they are worth, believe that by the time all of the new platters and equipment are in stores in quantity, business will pick up.

**A GENUINE EFFORT BY THE MANUFACTURER** and jobber to police list prices is not only sincerely appreciated by the profit-minded retailers, but is an outstanding method for obtaining and holding the loyalty of the dealer. Such loyalty results in increased sales of the product, and in willingness on the part of the merchant to spend money advertising the make.

**1949! RMA's 25th YEAR. . . TELEVISION's 10th YEAR. . . CALDWELL-CLEMENTS' 28th YEAR IN RADIO-TV PUBLISHING.**

*"UNFORTUNATELY, MANY OF THE EVIL practices that have plagued the radio industry . . . are beginning to show up in television. Shoddy merchandise, sometimes offered at cut rates and sometimes overpriced . . . has already shaken public confidence in some television areas. . . . In Chicago and New York, for example, 'gyp' competition has so demoralized the market that it is possible to buy many first rate products from almost any dealer at discounts of from 10% to 25% below list."*—H. C. Bonfig, vice-president, Zenith Radio Corporation.

**"TODAY'S MARKET FOR APPLIANCES** is rapidly becoming a buyer's market for the consumer, but is a 'salesman's market' for the wide-awake, alert manufacturer"—Raymond C. Cosgrove, executive vice-president Avco Manufacturing Corp. There is no lack of business for salesmen who will go after it the right way, Mr. Cosgrove says, adding that "Some people seem to be confusing the return to competition with a drying up of consumer needs."

**EASIER CREDIT NOW THAT REGULATION W** has been relaxed. The down payment has been reduced from 20 per cent to 15 per cent on electrical appliances and radios, and the monthly payments extended to 21 months. Dealer reaction is mixed, some feeling that the new terms will stimulate business; others that the stiffer requirements had helped to curb poor credit risks.

*THE CHICAGO PARTS SHOW, RMA's 25th BIRTHDAY, and Caldwell-Clements' 28th anniversary in radio and TV publishing will be celebrated in a special issue next month. All attendance records are expected to be broken at the Parts Show to be held at the Stevens, Chicago, May 17-20.*

**FMA SALES CLINIC BEING HELD** at New York's Commodore hotel, Friday, April 1, according to William E. Ware, president. Among the subjects to be discussed will be a report of sales results from special cooperative campaigns with dealers, manufacturers and advertisers.

*LOOK FOR A BIG YEAR IN CARRY-ABOUT sets. Portables will bring profits to the dealer who promotes them in 1949. They can be sold to people in all age and income brackets. Another good feature about the portable business, is that, over the whole picture, list prices of the carry-about stand up well.*



**HOT WEATHER IS BUT A COUPLE OF** months ahead. Now's the time to plan an active sales program on room-coolers, electric fans, and, of course, on refrigerators and food freezers. Red-hot promotion ideas such as "ice-cold" show-window displays, and clever advertising should be cooking in every merchant's mind right now.

*"THIS GREATER DISCRIMINATION ON THE part of the buying public, resulting in greater care on the part of store buyers, is a healthy condition which tends to influence the development of better products, better values, and better service to the public."*—Frank K. Runyan, president Western Mart, who commented that buying at the Mart indicates "optimism tempered by reasonable caution."

# Appliances, Records and Television

1949! RMA's 25th YEAR. . . . TELEVISION's 10th YEAR. . . . CALDWELL-CLEMENTS' 28th YEAR IN RADIO-TV PUBLISHING.

"MOST OF US FAIL TO REALIZE that the replacement market alone for electrical appliances today is as large as the entire market potential of replacement and new owners was pre-war. Washing machines and refrigerators often are replaced in less than 10 years. Since the records show that the big majority of these appliances were purchased prior to 1941, millions of them are now ready for replacement."—From a dealer bulletin issued by The Harry Alter Co., Chicago distributors.

A LARGE RETAIL FIRM, currently employing a number of outside salesmen, has found a way to determine which brands to stick with and which to discard. The organization, which refuses to cut prices, discovered that the salesmen automatically soft-pedal efforts to sell certain makes which prospects claim can be bought at "something off."

AUTOMOBILE SALESMEN AGAIN making instead of taking sales, as the car business commences opening up all over the country. Some experts look for the auto seller's market to end this summer, and if this does happen it will bring about new and very real competition in bids for the consumer's dollar.

SEVERAL INTERESTING MERCHANDISE techniques are being employed by the Hyland Electrical Supply Co., Chicago to promote its new TV program. More than 2,000 dealers were invited to participate in sponsoring the show without cost to themselves. Retailers were supplied with window streamers reading, "We are a participating dealer—'Women's Magazine of the Air'." Copy called attention to the station, WGN-TV, and to the time of telecast.

THE MUSIC SHOW BY THE NATIONAL ASSOCIATION OF MUSIC merchants, to be held at the New Yorker Hotel, New York, July 25, 26, 27, 28, promises to be a record-breaking event, with all-out interest to be focussed on TV and on the 3-speed platter situation, currently being cussed and discussed throughout the industry.

DON'T PUT OFF buying TV while awaiting the 16 inch tube, dealers should advise their customers. Rumors that the large size will be the most popular, and that all other set prices will drop considerably may ultimately prove true. But for 1949 the most optimistic outlook is that not more than 10% (or 200,000) of all the receivers made will have these tubes. Deliveries are likely to be spotty, also.

COLOR TV STILL A LONG WAY OFF. Dealers may confidently assure customers that there will be no color television for home receivers for at least five or ten years. There have been no recent developments in this field, but rumors are ever recurrent, causing prospective customers to defer buying.

TELEVISION RECEIVERS IN USE reached 1,410,000 as of April 1, with 60 stations on the air in 36 cities. Eight stations listed below are due to come on the air in May and June, bringing the total to 68 at the 1949 half-way mark:

WOR-TV	New York City, N. Y.
KECA-TV	Los Angeles, Calif.
WJAR-TV	Providence, R. I.
WDEL-TV	Wilmington, Del.
WFBM	Indianapolis, Ind.
KSL-TV	Salt Lake City, Utah
WCPO	Cincinnati, O.
WHTM	Rochester, N. Y.

## FUTURE EVENTS OF INTEREST TO READERS

APR. 4-5: West Central States, NAMM Regional Conference, Minneapolis  
APR. 5-7: Edison Electric Institute, 15th Annual Sales Conference, Edgewater Beach Hotel, Chicago  
APR. 11-13: Town Meeting of Radio Technicians, Ashland Boulevard Auditorium, Chicago  
MAY 1-6: National Electric Wholesalers Assn., 41st Annual Convention, Netherlands Plaza Hotel, Cincinnati  
MAY 1-7: National Music Week  
MAY 7: Eastern Electrical Wholesalers Assn., Dinner & Dance, Hotel Astor, New York City  
MAY 8: Mother's Day

MAY 17-20: Annual Radio Parts and Electronic Equipment Show, Stevens Hotel, Chicago  
MAY 19: Radio Manufacturers Assn., 25th Silver Anniversary Banquet, Stevens Hotel, Chicago  
MAY 31-JUNE 2: Edison Electric Institute Annual Meeting, Traymore Hotel, Atlantic City, N. J.  
JUNE 19: Father's Day  
JUNE 19-24: Store Modernization Show, Grand Central Palace, N. Y.  
JULY 2-9: New York State Assn. of Electrical Contractors & Dealers, Inc., Golden Anniversary Convention, Saranac Inn, N. Y.

JULY 25-28: National Association of Music Merchants, Annual Show, Hotel New Yorker, New York City  
AUG. 30-Sept. 1: West Coast Electronic Mfrs. Assn., 1949 Electronic Exhibit, 1949 IRE Western Regional Convention, Civic Center, San Francisco  
SEPT. 30-OCT. 9: National Television & Electrical Living Show, Chicago Coliseum, Chicago  
NOV. 13-18: National Electrical Manufacturers Assn., Chalfonte - Haddon Hall, Atlantic City, N. J.  
NOV. 14-18: 6th All-Industry Air Conditioning & Refrigeration Exposition, Atlantic City, N. J.

# New Radios, TV, FM, Phonos

## RCA Victor COMBINATION

The 648-PV combines the Crestwood AM-FM-shortwave-Victrola phonograph instrument with big-screen television, presenting 20x15 inch pictures, in a handsomely styled, traditional walnut or mahogany finish cabinet. The latter is so styled that all entertainment services may be completely concealed by ingenious door and panel arrangements. The five services, plus a roomy record storage compartment, are housed in a cabinet small enough to fit the average apartment: 39¼ inches high, 48½ wide, and 25¾ deep. Space economy is partially achieved by the use of miniature RCA Victor Preferred type tubes in the Crestwood roll-out radio-phonograph. The three-band radio and turntable with automatic record changer are integrated into a single compact unit which can be rolled out on tracks when a "drawbridge" panel of the cabinet is lowered. (Suggested retail price for the 648-PV is \$1,550.) RCA Victor Division, Radio Corporation of America, Camden, N. J.—RADIO & TELEVISION RETAILING.

## De Wald TV CONSOLETTA

Model CT 104 is a 12½-inch (approximately 75 square-inches) TV-only consolette with 22 tubes in a mahogany or walnut veneer cabinet measuring 38½ inches high, 20½ wide and 20¾ deep. List price is \$399.95. De Wald Radio Manufacturing Corp., 35-15 37th Ave., Long Island City 1, N. Y.—RADIO & TELEVISION RETAILING.

## Stewart-Warner TV SET

Ten-inch television consolette model has been designed to operate solely on Direct Current, making converters unnecessary in areas where this current is in use. Similar in appearance to the AC model AVT-1, the DC model will also retail at \$369.95. Stewart-Warner Corp., 1826 Diversey Pkwy., Chicago 14, Ill.—RADIO & TELEVISION RETAILING.

## Sparton TV SETS

New 1949 models featuring three new four-way combinations; two TV table models. Four-way combination, model 4916, is priced at \$399.95 east of Rockies. Each new model has a 10-inch screen with 54-inch picture, automatic brightness control, 28-tube chassis, plus four dual-purpose tubes, and a choice of mirror-view screen or direct-view screen. All combinations have dual-purpose, single-arm, two-speed record changers, for 78 RPM and LP records at 33 1/3 RPM, played automatically. Model 4916, hand-rubbed mahogany, has two companion models, model 4917, at \$419.95 east of Rockies, and model 4918, at \$439.95 east of Rockies. The two new table models offer a choice of mahogany or bisque finish at \$269.95 east of Rockies. Sparton Radio Television, Div. of The Sparks-Withington Co., Jackson, Mich.—RADIO & TELEVISION RETAILING.

## Emerson TV SET

Emerson model 618 has a 91-square inch picture screen (12½" tube), in combination with FM and AM radio and phonograph with automatic record changer, encased in a console cabinet of matched crotch and striped mahogany veneers. Emerson Radio & Phonograph Corp., 111 Eighth Ave., New York, N.Y.—RADIO & TELEVISION RETAILING.

## GE TELEVISION SETS

New line of low-priced television receivers, using a simplified circuit design necessitating only 17 tubes and three rectifiers in addition to the 10-inch picture tube will comprise three table models and one console. Lowest priced will be a molded-plastic cabinet table receiver, model 805, which will have a list price of



\$239.95. The remaining table sets, model 806 in mahogany and model 807 in native American oak, will have list prices of \$279.95 and \$289.95 respectively. Model 809, a compact contemporary console finished in mahogany, will list for \$329.95. (All prices are Eastern.) General Electric Co., Electronics Park, Syracuse, N.Y.—RADIO & TELEVISION RETAILING.

## Wilcox-Gay RADIO-PHONO COMBINATION

Model 9G10 comprises an AM-FM radio and dual-speed disc-recorder and record player in a leatherette carrying-case. Recording can be made direct from the radio provided. Wilcox-Gay Corp., Charlotte, Mich.—RADIO & TELEVISION RETAILING.

## Philmore TV KIT

Featuring circuits similar to the RCA 630TS and 8TS30, this kit comes with tuner, video and sound channels completely wired and pre-aligned. All components (tube sockets, transformers, can conden-

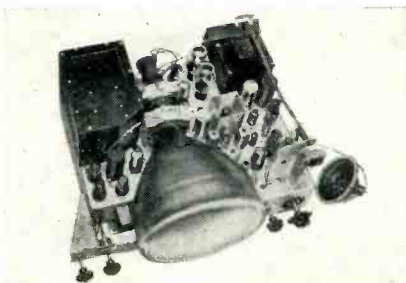

sers, etc.) are mounted on the chassis by Philmore. Step-by-step instructions, a 36-page instruction book, and six 2 by 2 foot blue-prints are provided. Philmore Manufacturing Co., Inc., 113 University Place, New York 3, N.Y.—RADIO & TELEVISION RETAILING.

## Admiral RECORD CHANGER

Admiral Corporation has introduced a record changer with one tone arm that will automatically play every size record both standard and long-playing at all the turntable speeds now on the market—33 1/3, 45, and 78 RPM. Deliveries will be made in this month to Admiral dealers of the 24 models in the Admiral line of radio-phonographs and television combinations so equipped. Included in the line are two table radio phonographs, five console radio phonographs, and 17 tele-

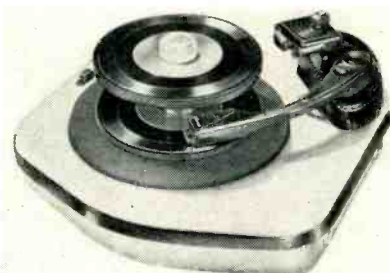

vision combinations. All Admiral radio phonographs from \$69.95 and up and all Admiral television combinations will be equipped with the new "Triple Play" automatic record changer. In all television combinations the new record player has been combined with Admiral's FM-AM Dynamagic radio. This chassis permits all FM-AM circuits to be combined with the record player in one unit. The radio-phonograph is powered by the television power supply. Admiral Corporation, 3800 W. Cortland St., Chicago 47, Ill.—RADIO & TELEVISION RETAILING.

## ZENITH RADIO

Zenith Radio Corp., has announced the addition of a new "furniture styled" radio-phonograph console combination to Zenith's line of receivers, as well as a table model radio-phonograph which features Twin Cobra tone arms for long playing and standard records. The new console, in genuine mahogany veneer and selected hard wood, reflects the Hepplewhite period of furniture design. The set offers Zenith-Armstrong FM, and standard reception which tunes the full broadcast band from 535 through 1620 kilocycles. The console is an addition to Zenith's 9H series. Suggested retail price is \$329.95. The table radio-phonograph model, which retails for \$99.95, is equipped with Twin Cobra Tone Arms and a dual-speed motor. Long playing records are controlled manually.

Zenith Radio Corp., 6001 W. Dickens Ave., Chicago 39, Ill.—RADIO & TELEVISION RETAILING.

## Video TV TABLE SET

Model VS-120 is a 90-square inch television-only table model receiver with improved circuits housed in a hand-rubbed cabinet. Model will retail for \$395. Video Corp. of America, 385 Flatbush Ave., Brooklyn, N. Y.—RADIO & TELEVISION RETAILING.



Norelco  
Presents  
Miraculous New

# Life-Size<sup>more</sup> Life-Like

Television

A Great New  
Television Development...

## PROTELGRAM

by

NORTH AMERICAN PHILIPS  
COMPANY, INC.

...from this small 2½" tube



Available now—or soon  
in these famous  
quality TV Receivers

ANSLEY · EMERSON

FADA · FISHER

PILOT · SCOTT

STEWART WARNER

INTERNATIONAL  
TELEVISION

BRUNSWICK

and others soon to be announced

PROTELGRAM

for  
life-size,  
more  
life-like  
television



# BIG Pictures Mean

**Vast Untapped Market for Large-Screen  
Television Ready for Dealers — Features of Projection Video Described**

Size of image is an important feature in selling receivers to the public these days as TV interest reaches new heights.

The one thing that the television customer wants above all others is a large picture. He usually winds up getting the largest picture he can afford, since price has set the size up to this time. With set manufacturers working hard to resolve the paradox of larger pictures at smaller prices, solutions have come up which now actually give the customer a choice *within a given price range*.

The dealer who is smart enough to offer the customer more picture for the same or less money is an odds-on favorite to make the sale. A rudimentary understanding of the basic principles underlying the different values now available will aid the dealer in selling so that customer gets what he wants and knows what he is getting.

In order that we may examine the different types, it will be necessary to make a few remarks on the nature of the TV picture. The transmitted picture is a rectangle with an "aspect ratio" of height to width of 3 to 4. The picture tube (cathode ray tube or kinescope) has a round face on which this rectangle is "painted."

## Methods Employed

The picture tube determines the size of the picture. As a matter of fact, in order that the entire transmitted picture be shown on the circular tube, it must be considerably smaller in area than the face of the tube. Various

methods have been worked out to get larger pictures on a tube as outlined in the February issue of RADIO & TELEVISION RETAILING, but it is not possible to obtain a direct-view picture larger than the picture tube.

The two directions in which manufacturers are exploring the larger picture problem are (1) large direct-view tubes, and (2) projection television. Dumont in particular has pioneered in the large tube field, with kinescopes up to 20 inches in diameter. Although we may eventually expect kinescopes to be produced much more cheaply than they are today, we at present find that the tubes go up in price astronomically with increased size. The long-heralded metal-envelope tube (now available in 16 inch size) may provide the answer to this problem, when sufficient quantities become available.

## Projection Features

The projection type screen is distinguished in appearance by a flat, square-cornered picture. It is distinguished in method by the fact that we no longer look directly at the face of the kinescope. Instead, a small tube, known as a projection kinescope, throws its light through a system of lenses and mirrors onto a screen. This screen may be fixed into the cabinet of a set (finite throw), or hung on a wall (infinite throw). The projection tube operates at high voltages (up to 27,000 in home receivers and 80,000 in theater types), producing much higher brilliance and finer detail than an ordinary kinescope. This is necessary, since any optical system which passes the light through lenses or reflects it against mirrors will lose some of the brilliance, and diffuse it to some extent. Although this is true of projection TV, the optical efficiency of

the reflective optical systems used is actually better than fine camera lenses. Advocates of projection TV point to its large size at a relatively low cost per square inch, and its easy-on-the-eyes soft tones, which are likened to a matte finish photo.

## Saves Cabinet Space

An additional feature of projection sets is that it is possible to obtain them in smaller cabinets than large-tube direct-view sets. This means less money for cabinets, as well as an easier problem in fitting into the home. As an example, one model (the Scott) produces a picture 12 x 16 inches in size in a cabinet 25 inches wide, 22¼ inches deep, and 14 inches high. Here the picture, more than ¾ larger in area than a 16 inch and almost as large as that on a 20 inch tube, is in a cabinet comparable in size to a 10 inch set.

Cabinet space is saved, in the first place, by the use of a smaller kinescope, and in the second place in the "folding" of the light beams (by means of reflection off inclined mirrors) between the tube and the screen. The method of folding the light beam is comparable to the operation of a periscope.

The various picture sizes now available are shown on adjoining page for comparison purposes.

Since very few people can visualize the size of the picture when told either the dimensions or the area in square inches, it is suggested that the dealer have mounted on his wall some photos or cards for each size so that the customer can readily compare them visually.

The advantages of big pictures generally, by whatever method they are obtained, are several. In the first place, the viewer needn't sit so close to ob-

# BIG Profits

## Approximate Areas, in Square Inches, of Various Sizes of Picture Tubes

3" direct view	about 5 square inches
7" direct view	about 26 square inches
10" direct view	about 52 square inches
12" direct view	about 75 square inches
15 or 16" direct view	about 125-135 square inches
12 x 16 inch projection	192 square inches
20" direct view	about 222 square inches
15 x 20 inch projection	300 square inches
18 x 24 inch projection	432 square inches
20 x 26 inch projection	520 square inches
Wall Projection	6 x 8 ft. and more

serve detail, and more viewers can therefore be accommodated.

As a matter of fact, the best viewing distance from an optical standpoint is considered to be about 6-8 times the picture height. For a picture about 6 inches high (on a 10 inch tube) this would be 3 to 4 feet. For a 15 x 20 inch picture it would be 7½ to 10 feet. The size of the living room will, therefore, have some bearing on the choice of the set.

If the viewer sits too close (as is the popular tendency) so as to distinguish the individual scanning lines which make up the picture, eye-strain will result.

### Viewing Effects

In the second place, the picture is large enough that the eye needn't wander off it when sitting at the proper distance. This means that it would be possible to view the set in a darkened room without constantly adjusting the pupil of the eye from dark to light as it sees first the bright screen and then the dark surroundings. While developments in the art of television will no doubt eventually make it possible to get absolute black on a screen in a lighted room, at present the darkness of the black is limited to the appearance of the screen when the set is turned off. In a desire to get more contrast (that is difference between the light and dark),

Demonstration of the TV sets under ideal conditions brings real results. All eyes are on video today, and the demand is increasing all over the country. Sell big pictures to make more money and to make more friends of customers. Thorough knowledge of projection operation and features is a must for every retail sales force.



most viewers make the whites too bright, which is another cause of eye-strain. Medium sized sets should be viewed in a room with some light on (but none falling directly on the picture) with the picture adjusted for the greatest number of variations in hue (it will be generally of a grey color), and viewed from the proper distance.

### Sells Actively

As to the question which type (direct-view or projection) provides the best picture, there is no need to discuss this in the printed pages of a magazine when the dealer has the answer on his own sales floor. Turn them both on and let the customer decide. It will be found that a large picture has a magnetic attraction for the customer, regardless of the method used to produce it.

Finally, we find the projection set in most cases offering larger pictures per dollar in less bulky cabinets—potent sales arguments which the dealer may pursue to up his average unit sale and his profit in 1949. Whether the issue is price or size, sell projection for all it's worth this year.

# How to Cope With

**For the List-Price Minded Dealer,  
There's an Antidote for  
Today's Number One Headache**

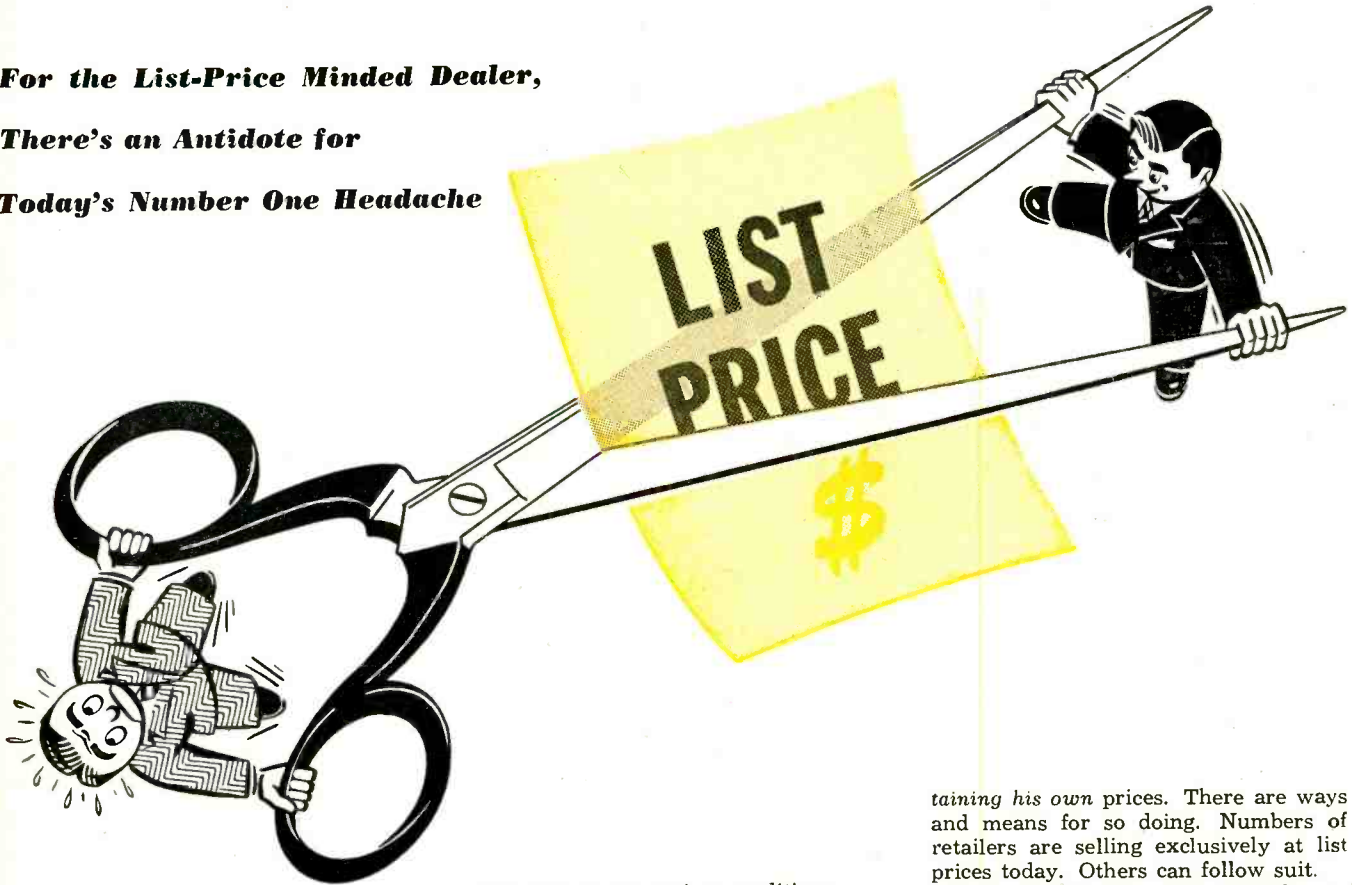

• It is not necessary to tell any dealer that price-cutting is on the increase. He knows it only too well. Nor is it news to him that discount-houses are mushrooming in many of the large cities, and that established cut-price artists are sharpening their pencils the better to draw up ads featuring but one thing—*reduced price*.

The dealer who is trying to maintain list-prices is deeply aware of the situation. Merchants in or near the big cities are feeling the effects of the new wave of price-surgery more keenly than those in smaller areas, particularly the more or less isolated ones. However, the latter group are worried because of the constant threat of expansion of the industry's Number One Evil.

## **Profit-less "Price-Fights"**

Yes, news of the out-and-out resumption of price-cutting is old-hat to the merchant. It's bad news, and so far as the industry is concerned, it doesn't seem likely that anything more will be done about it now than was done in the past.

Wide-scale cooperative attack on price-cutting seems a long way off.

Breast-beating will get us nowhere, nor will weeping in our beer serve one

whit toward improving conditions.

There's nothing new in the price-cutting racket. It's old stuff any way we look at it, but it's still the Big Bad Wolf of merchandising.

Numbers of merchants thoughtlessly jump into the battle in attempts to get their share of the business by cutting under the other fellow. Many have publicized their stores for so long a time as headquarters for cut-prices that they have built a following of chiselling customers who demand a break or else! In many instances, such outlets no longer know how to sell "straight." Their salesmen get over that "I'll-tell-you-what-I'm-going-to-do" line before the customer opens his mouth.

The dealer, who because of narrowed profit margins and upped operating costs is trying to sell his products at list prices is up against a real problem. He knows the causes and the effects of price-cutting. (See accompanying panel.) He would like to see something done about this evil—something which would control the situation. But, in the meantime, he is faced with the necessity for keeping his own business in the black, meeting his own payroll, and banking a few dollars in the form of profit to pay him for his long hours and hard work.

So far as his own particular business is concerned, the merchant who sincerely desires to do so can keep his establishment on a level keel by main-

taining his own prices. There are ways and means for so doing. Numbers of retailers are selling exclusively at list prices today. Others can follow suit.

To begin with, the profit-minded merchant must steel himself against the temptation to go to the mat with the chiseler and fight it out on a sell-to-the-lowest-bidder basis. This temptation is very real—very potent. It's one thing to say, "don't cut your prices." But it's another thing to face shopper after shopper and listen to the same line—"I can get it cheaper at ———." No merchant likes to see a lot of people walk out without buying.

## **Getting a Square Deal?**

First, then, the dealer needs to stiffen his backbone in dealing with the "price-shopper," and concentrate on his good customers, offering them more for their money than the price-cutter does—and to stress such extra value via better, more courteous salesmanship.

Let's see what sort of ingredients go into the formula for maintaining list prices, dealing exclusively with *standard, non-distressed products which are currently in demand*.

Looking at the whole situation in a realistic manner, we find that *careful buying* is of utmost importance. So far as a specific brand is concerned, ask yourself the following questions: Is the make being battered around to every Tom, Dick and Harry? Is the manufacturer (and jobber) interested in maintaining the price? Are you advised in advance of the advent of new models?

# PRICE-CUTTING Competition

Is the make acceptable in your trading area? Is the price in line?

Next, let's look into the policies of the supplier—manufacturer or jobber. Are you getting the *same* discount rate as others for *same* amount of merchandise bought? Are you *forced* to take assortment deals? Do you obtain fair adjustments on defective parts, under-guarantee service, etc.?

After a careful analysis, if the merchant can satisfy himself that his products and his suppliers are satisfactory, he needs next to go into the selling end of his business.

## **Service a Big Factor**

Of vital importance in justifying the asking of a full list price is the operation of a first-class service department, and to use such service facilities to clinch sales, and to give the customer *more for his money*.

In meeting cut-price competition, the retailer who has a strong service organization should use this ace in the hole to attack the discount house and price-cutter who, more often than not is notoriously weak on service.

Remember that even the greatest chiseler on earth will think twice before buying a product at a slashed price if

he can be convinced that it may cost him more in service than he saved in original cost.

One successful price-holding retailer whose business is in a trading area near a large city just teeming with price-cutters, says that he *concentrates his efforts on good customers*. Customers who know the value of service, and that he and his salesmen never worry over the loss of a "price-shopper" who walks out blissfully unconvinced after a sales talk. The dealer who builds up a reputation for being "fair" always obtains a following of "fair-minded" people. The dealer who always offers something "off," builds up a following of folk who take him for granted as a "cheap" merchant.

More often than not, local organizations such as boards of trade, can be made to help local businesses keep "clean." Dealer groups are quite effective in many areas, too, and merchants should join them in order to help along with the good work.

Distressed prices are most harmful to brand names, and no reputable manufacturer wants to see his make ballyhooed in cut-price advertising. Farsighted distributors want no part of price-cutting either. They know that

---

## **Here Are Some of the Things That Breed Price-Cutting**

**Over-production**

**Longer discount rates to "pet accounts"**

**Assortment Deals—Dumping**

**Back-door selling by distributors**

**Products too high-priced or not in demand**

**Stagnant inventories—need for ready cash**

**Stores always featuring price-cut merchandise**

**Disregard of need for policing prices by certain manufacturers and wholesalers**

**Surprise launching of new models**

---

it's difficult to get "repeat" business from the dealer on products that have been slashed.

The merchant who sees his competitor cut prices on the same merchandise which he stocks, and which he attempts to sell at list under Fair Trade laws, has a perfect right to hit the ceiling. Furthermore, he is entirely justified in complaining to the wholesaler and to the manufacturer. He has a right to demand an explanation . . . to question the discount rate the other fellow obtained, and to otherwise fight for his rights. Price-cutting is an all-industry problem. It is a job for all of us to attack with vigor.

## **For Full Profits**

In his own business, though, the problem is immediate, and, is more or less under the dealer's own control. While he participates in efforts to get industry-wide cooperation in "cleaning house," he must first put his own establishment in order. He can do this by fighting for his rights in being his own "boss" so far as selecting brands is concerned; upping salesmanship, and bettering customer relationships. And by providing the kind of service that convinces even the most skeptical buyer that he is getting *more for his money*—even at list price.

---

## **Sell at LIST NOT at AUCTION!**

**Do These Things to Help Keep Your Business on a Profitable Basis—**

- 1. Buy with an eagle-eye—Get a fair deal**
  - 2. Maintain and publicize top-flight service**
  - 3. Sell—don't chisel. Use salesmanship always**
  - 4. Give the customer something extra in service**
  - 5. Complain about price-cutter to your suppliers**
  - 6. Cultivate customers—bypass "price shoppers"**
  - 7. "Shop" other stores to keep posted on prices**
  - 8. Get reputation for being "fair"—not "cheap"**
  - 9. Weigh value of all trade-ins before accepting**
  - 10. Don't lose sleep over other fellow's tactics**
-

# Save Money on TV Servicing

**Eliminate Costly Nuisance Calls, Preserve Good-Will**

It is conservatively estimated that each TV set sold in the past two years has averaged about 6 service calls a year in addition to installation. It has been the experience of TV dealers that this high rate has made operation under the one-year warranty fee hazardous, and yet it is usually agreed that a large percentage of these calls are unnecessary.

Obviously the elimination of so-called "nuisance calls" would make operation under the guaranty more palatable to the dealer, and most likely profitable, while at the same time maintaining good-will and bringing in new customers from the recommendation of satisfied users. Yet the relatively simple method of reducing the number of such calls is often overlooked.

Nuisance calls result when the customer 1) Doesn't know how to operate the set properly, 2) Doesn't understand the nature of TV reception problems, and 3) Is not aware of broadcast transmission failures and weaknesses.

This situation arises when the customer is either *oversold* on the perfection of his purchase, or *not sold at all*.

## Ready-Made Customers

Many a dealer has found to his delight that customers walk into his store having already decided that TV is the greatest invention since the horseless carriage, and the conversation becomes merely a question of delivery. Such a customer may be laboring under many delusions about television itself, and about the particular set he has picked

out. He may well become a source of nuisance calls, just as the fellow who is given a sales talk in which features are deliberately or ignorantly misrepresented.

Selling TV is a specialized job requiring much more concentration and application on the part of the salesman for this reason: unlike most of the other merchandise in the radio-appliance store with which the public has been familiar for years, television is a more or less unknown quantity. The situation is further complicated because, due to the high interest in that subject, the air is full of rumors and misinformation needing clarification by the retailer or the salesman.

## Selling Programs

The salesman must know all about the stations on the air in his area; what the maximum will be, and when other stations are expected. Some cities have only been allocated one TV channel. It would be a grave error to highlight the "12 channel" capabilities of a set in such a city without explaining in detail the number of stations within range. As a matter of fact, the maximum allowable in any city is seven channels. The customer should be informed of exactly what to expect in his locality.

Many customers are under the delusion that TV is the visible representation of radio, and that they will see the programs they are accustomed to listening to. It should be pointed out that if

the set has no radio, it will not pick up any radio programs.

It is wise for the dealer to keep handy a schedule of the local TV programs so as to be able to show the customer exactly what to expect, and at the same time "selling" the prospect on the good things on the air.

## Anticipating Complaints

The second thing the dealer must know is how to operate all the sets he carries, with ease. The customer who signs on the dotted line should be "checked out" on the controls at least one time in the store. It is suggested that the dealer make a house call soon after delivery to go over this, or make sure that his installer does. The customer should be shown, not only how to operate the set properly, but what it looks like when the controls are misadjusted, so he can recognize the symptoms.

The third thing that the dealer must understand fully is reception. Perfect reception on all channels cannot be taken for granted, and the customer should not be led to believe that the price of the set or the reputation of its manufacturer has anything to do with this. As a general rule, weak signals, ghosts, diathermy, ignition interference, and radio-frequency interference are just as bad on an expensive set as they are on a low-priced one. It should not only be made clear that such things exist and may occur, but also that they are a problem of reception and not of the set itself. A good installation is, of course, mandatory, but some locations are bad in themselves.

In this connection, it would be a good idea for the dealer to keep a card file on his customers, noting the reception at each location. This will make it possible to check up on a given neighborhood or even a certain building in order to estimate the results obtainable there.

Station failures and difficulties should not be blamed for all the customer's troubles. However, it will be worth the dealer's while to keep in touch with the situation closely enough so that he can explain these when they occur. For instance, occasionally a station will break down for a few minutes in the middle of a program. It is customary for a new user to turn off the set, believing that it has gone bad, and next morning to report a dead set. If the dealer is aware of what happened, he can explain to the customer and avoid

(Continued on page 108)



Sell TV sets the right way to keep them sold, to keep customers satisfied, and to save money on service.

**Du Mont**  
invites comparison  
—and the dealer who sells by  
these same tactics will find he has  
bigger unit sales and better  
satisfied customers.

*What  
to look for  
in Television*

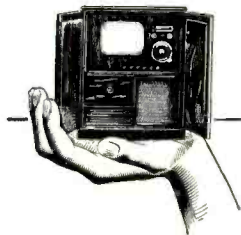

**Use this check list  
when you select  
a television receiver**

- You'll want a big screen—one big enough for the whole family to watch the big events. All Du Mont Telesets\* have large screens—none smaller than 72 square inches—some as large as 213 square inches.
- You'll want a direct-view screen. A demonstration will show you why. The Du Mont direct-view pictures are clear; brilliant even in a normally lighted room; free from distortion at any angle.
- You'll want easy, accurate tuning. Du Mont's patented Inputuner\* permits you to tune quickly with hair-line precision. And it stays tuned.
- You'll want full range FM radio coverage and all 12 television channels. Be sure to check this one.
- Since television is something everybody looks at, you'll want a handsome cabinet... designed in good taste; made of fine woods; a beautiful piece of furniture that will enhance the other furnishings of your home.
- You'll want an instrument that will give you long and dependable service—made by a reliable maker with long experience in all phases of television.

Make this point-by-point check; see if Du Mont doesn't give you the most real value in television receivers.



**Do you want a complete home-entertainment instrument?**

A distinguished Du Mont console like the Calany gives you everything—and the finest of everything. Television on a 116 square-inch direct-view screen; high-fidelity sound on AM and FM radio, and a wonderful automatic record player. **\$945.**



**Do you primarily want television and FM?**

Then a Du Mont table-top set like the Chatham will give you superb television in compact, inexpensive form... a 72 square-inch direct-view screen, plus static-free FM radio.

**\$425**—natural mahogany veneers.  
These are only two of a complete line of DuMont receivers.

**DU MONT** *first with the finest in television*

# How to Charge for

## Eliminate Guesswork by Systematic Methods— Simple Forms Require Minimum Paperwork

The principal ingredients of the estimate for repair work are speed and accuracy. The customer dislikes having to leave the set for an estimate, he dislikes being asked to pay more than the estimate, and he dislikes waiting longer to get the set back than he was told at the time of the estimate.

From the dealer's point of view, speed is important since the time spent estimating may be unproductive; and accuracy is important, since he may have difficulty collecting for a repair charge which is greatly in excess of the estimate.

Working the "test and estimate" task down to a routine suggests itself as the only feasible method of attaining speed and accuracy. This can be broken down into three steps: 1) Checking to determine the trouble 2) Evaluating the cost of making the repair and 3) Explaining the estimate to the customer.

### Keeping a Log

In order to eliminate the guesswork from both estimating and repairing, it is suggested that a "repair log" be kept of all work done. One way of doing this is to use a sales book, and keep track of the repair on one of the duplicates. From time to time these slips can be compiled until fairly reliable averages are obtained for most troubles.

The original slip, a copy of which might serve as a receipt to the customer, would carry the following information: Customer's name and address, make and model of set, customer's description

The second installment of a series. Part I appeared in March and outlined a formula for pricing service work. The current installment covers estimating and guarantees.

of trouble, diagnosis of trouble by estimator, and estimated cost of repair and time of delivery. The copy of this slip which is retained at the bench would be further filled out with: time started work, work done (such as: replaced open C167, soldered cold joint pin 3 6SA7, etc.), time completed work. The charge made to the customer would be entered on this slip and it would be filed for future reference. The customer's slip would have the repair and the charge entered on it, and also the warranty, if any.

The shop record would then show, for each repair, the customer's complaint, the estimator's diagnosis, the actual trouble and work done to repair it, the time spent fixing it, and the charge for the repair.

A compilation of such slips could then serve as a guide in estimating future repairs. It would also serve to show what were the most recurrent troubles in all sets, what were the most recurrent troubles in particular sets, and where to look for troubles having certain symptoms.

The troubles could be listed under three headings: Dead set, intermittents, and distorted output. Naturally this article on estimating costs cannot

also be an encyclopedia on repair work, since space would not permit digression into the method of analyzing the various troubles which will crop up. It is likely that the experienced servicer has already established short-cuts for himself in diagnosing troubles under those three main headings. Suffice it to say that certain routine checks should be made, and that the more scientific the checks appear (that is, using a meter, tube checker, signal generator or the like), the more impressed the customer will be that the repairer knows what he is talking about.

### Care in Estimating

To the experienced servicer it may seem superfluous to mention that a set may have more than one trouble, but this fact becomes important in explaining the estimate to the customer. A dead set may turn out to be distorted or intermittent when in operation. The set may have troubles that the customer hasn't noticed (such as distortion, long warmup, low sensitivity, etc.) or that he hasn't considered important (dial cord slippage, pilot light out, etc.).

The servicer obviously has two courses of action: to fix only the cause of trouble mentioned in the estimate, or to put the set in as good working order as it is possible to do. In this connection, it will not be amiss to repeat the fact mentioned in the first installment of this series of articles, namely: the customer is not interested in having a tube or a condenser replaced. He is only

This repair log can easily be compiled from work slips on the opposite page. It will quickly reveal the average time and charge for typical jobs, and average number of jobs done per day.

Month .....								
<b>YOUR Radio Co.</b>								
Day	Customer	Set Make & Model	Trouble	Work Done	Parts	Tubes	Hours	Charge



# Profitable Servicing

interested in having the set working properly and permanently.

This immediately suggests to the servicer that he should describe the trouble to the customer in terms of its symptoms rather than in terms of the parts needed. For instance: "Sound tinny on high volume due to tear in speaker cone. Replaced cone. Sound o.k." If additional work was done which the customer might understand, it should be noted: "Air-cleaned set . . . checked reception over entire dial . . . bench-checked for two hours . . ."

Estimating the time the set will be ready involves more than just the time required to repair it. The dealer must consider the backlog of work to be done. In order to facilitate the estimating of time, it is suggested that the work slips mentioned earlier be kept in a prominent place attached to two clipboards. One of these would be for jobs not done yet, and the other would be for the finished work. The work-to-be-done board would, of course, be kept in order of receipt of the work, with each new job being put on the bottom.

Where a large volume of work is handled, these slips may be stamped with a number indicating the date received. This number should be as large as possible, and a different color from the rest of the slip (a changeable date stamp and a red ink stamp-pad will do the trick). In this way a quick riffle of the slips will reveal how many days backlog is on hand.

The file of completed jobs may be removed to a permanent file either daily or as the jobs are picked up by the customer. If the latter method is used, the clipboard of complete work will be an instant indication of sets which have lain around for quite a while without being picked up, especially if they have the red date number suggested above.

A couple of weeks of this type of operation will make it possible to estimate the average number of jobs completed each day, so that estimating time of completion will be simplified.

## Warranty Policy

The final element of the repair estimate (radio or TV or record changer) is to have a definite policy on warranties and to make this clear to the customer. We have made the point before that the customer is interested in music, not new tubes. Therefore it seems logical that there should be a warranty of some sort.

In order to impress on the customer that the warranty is in the nature of insurance involving some risk to the servicer, it might be handled by offering two charges for the repair: 1) a price

Typical sales book which could serve as receipt, work record, sales slip, warranty and bookkeeping record. 1 copy goes to customer, 1 to shop, 1 to business file. Large 12 is the date stamp.

for the specific repair, 2) an addition, probably a percentage either of the repair cost or the set value, to cover a guaranty of the entire set for a specific period. The sales slip issued when the repair was complete would then indicate to what extent the work was guaranteed. This would ultimately result in a more satisfied customer than would be the case if the explanation came when the set was returned for the second time. The customer always feels that it's the same trouble it had before,

or that it never really was fixed.

In this connection, it is an advisable practice where possible to play the set for the customer at the time it is returned or collected to establish the fact that it has been repaired and returned in good condition.

\* \* \*

The next installment of this series will cover the relation between service charges and value of set, how to collect for servicing, and how to promote servicing business.

# GENERAL INDUSTRIES leads the L.P. Parade...

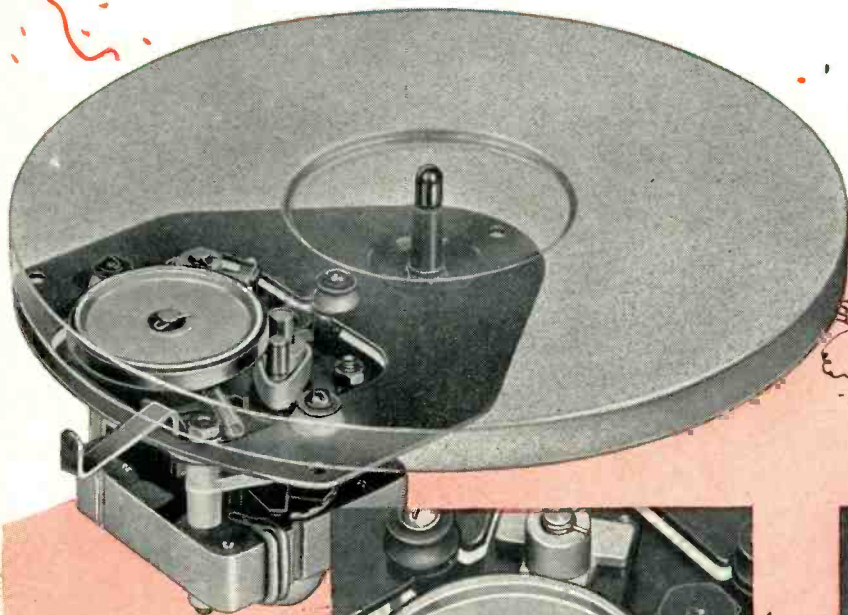

**MODEL DM**—Compact 2 pole, shaded pole motor, already being widely used by many of America's leading radio and record-changer manufacturers. Simple speed change mechanism incorporates a special long-lasting molded neoprene belt. Speed change lever extends beyond turntable rim

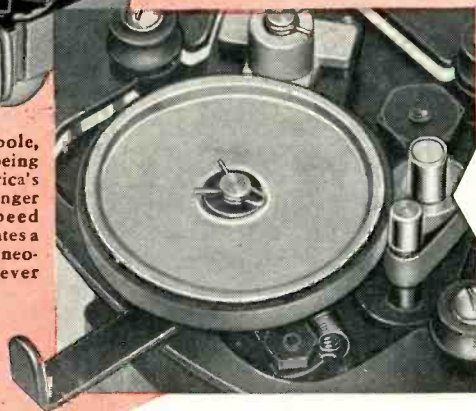

78  
RPM



33 1/3  
RPM

## with a low cost, rim drive **DUAL SPEED PHONOMOTOR** FOR BOTH 33 1/3 AND 78 R.P.M. RECORDS

It's L.P. for *Larger Profits* when your record-changers and record-players will handle both the new long-playing microgroove and conventional 78 R.P.M. records. And it's General Industries—oldest name in the phonomotor field—which offers you an economical turntable unit to capture this popular, profitable market.

Like all GI Smooth Power products, this

motor has undergone tests far more rigid than service conditions encountered in normal use. It is the result of years of research and development . . . built to exacting performance standards, but surprisingly low in cost.

General Industries offers prompt delivery of this motor in quantity lot shipments. For additional information, specifications and quotations, write *today*.

In addition to the Model DM, General Industries also manufactures a Model DR rim drive dual speed phonomotor. It is a heavy-duty 4-pole shaded pole motor for use where the ultimate in performance is desired. Novel speed change mechanism is both simple and positive in operation.



**The GENERAL INDUSTRIES Co.**

DEPARTMENT I • ELYRIA, OHIO

# RECORDS

Section of **RADIO & TELEVISION RETAILING**

## How to Demonstrate and SELL, RCA Victor's Record Playing System

A powerful sales promotion campaign is under way by RCA Victor to launch the new 45 RPM record playing system. Advertising copy stresses the theme, "Ask for a demonstration of the 'new and sensational' system." National advertising, customer brochures and dealer displays play up this idea.—The might of advertising dollars is directly behind the dealer, and aimed squarely at the customer in an effort to get him into the dealer's store.

Magazines, radio, television and newspapers have been employed to carry the story of 45 RPM to the public. A three-month period of intensive advertising has started this month. Newspapers in approximately 100 different markets throughout the United States carried advertisements introducing the

new RCA Victor records and players. Follow-up ads in these trading areas are scheduled to follow at regular intervals.

RCA Victor has also provided distributors with advertising kits containing special spot-commercial films for use on TV and with sample scripts for local radio broadcast use.

The barrage of 45 RPM news which will hit prospective purchasers from all sides, actually reaches its target only when the prospective purchaser walks through the door of a retail establishment. Then the dealer takes over. It is up to him to clinch the sale; to demonstrate the new records and equipment so that the listening customer will be impressed by what he hears and sees.

It has been recommended that whenever possible, the retailer utilize the 45 RPM record playing attachment (9JY) for use with the RCA Victor "Crestwood," for in-the-store demonstration of records. However, the complete table model phonograph (9EY3) equipped with its own amplifier and loudspeaker, can also be used with complete confidence in its ability to perform well.

### Complete Unit

The 3-tube table model phonograph has been hailed by the manufacturer as giving dealers an unprecedented opportunity to sell an extra phonograph in the home. "A phonograph in every room" campaign has been suggested—a new trend—to get away from the idea of having only one major instrument in a home. Ease of operation, simplicity of loading and unloading records, fool-proof mechanism, small size, it has been pointed out, makes this unit ideal for use by children, in play-rooms and bedrooms.

The appeal to newlyweds, or other families with problems of limited budgets—and space—is obvious. Dealers would do well to stress these two factors when approached by people who are starting or enlarging record collections.

Several jobbers have already an-



Demonstrator unit, 23 inches high, 21 inches wide, 11 $\frac{3}{4}$  inches deep, can be used to actually demonstrate the records.

nounced their intentions of featuring the 45 RPM independent playing unit in special college promotions, playing up the theme of minimum space problems, unbreakability, lower cost, and automatic playing. The opportunities for finding added promotional tie-ins for the new equipment is as boundless as the individual dealer's energy.

It should be pointed out to customers that the record playing attachment will play through any radio or phonograph they presently own, regardless of make.

(Continued on page 78)

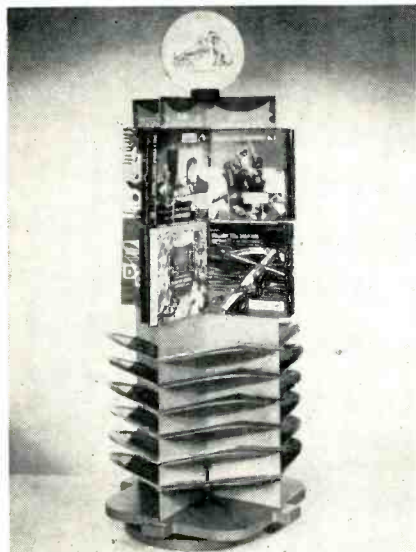

Record counter turnstile stocker, 43 inches high, 16 inches deep, 16 inches wide. Unit revolves on circular woodbase.

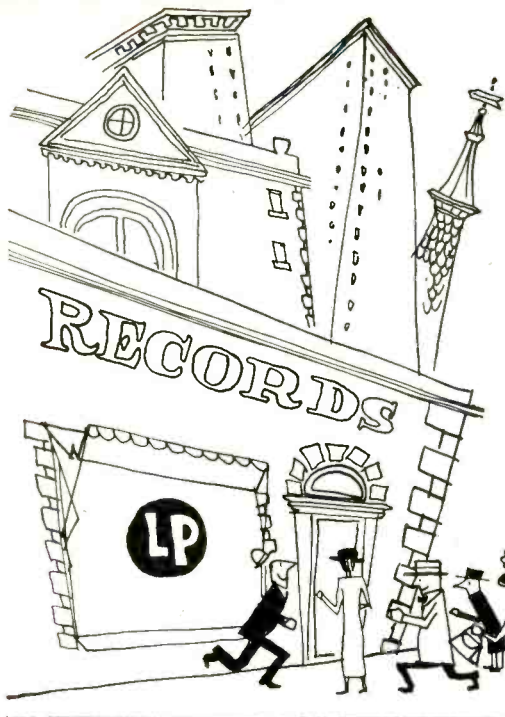

# means

## ...because

over 600,000 LP-equipped families (hundreds in your own community) are today America's biggest buyers of phonograph records!

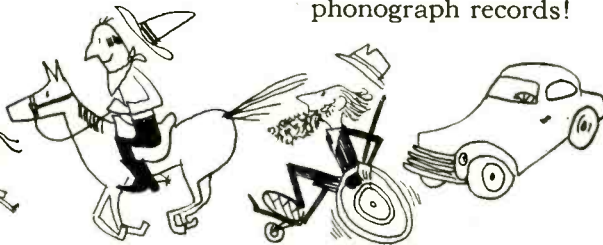

## ...because

every 33 $\frac{1}{3}$  rpm LP player you sell creates a *new*, record-hungry customer for you!



## ...because

only LP Records play up to 50 minutes and satisfy the classical music lovers' desire for *uninterrupted* music. No other recording-speed does this!

# Larger Profits!

...because



every type of music is on Columbia LP Records—Masterworks, popular, semi-classical, folk music, children's selections. Also single selections on the new 7-inch Microgroove Records. New releases every month to keep your sales lively!

...and because



every sales effort you put behind LP today means years of better business for you in the future! Capitalize now on this enthusiasm!

## COLUMBIA **LP** RECORDS

MICROGROOVE

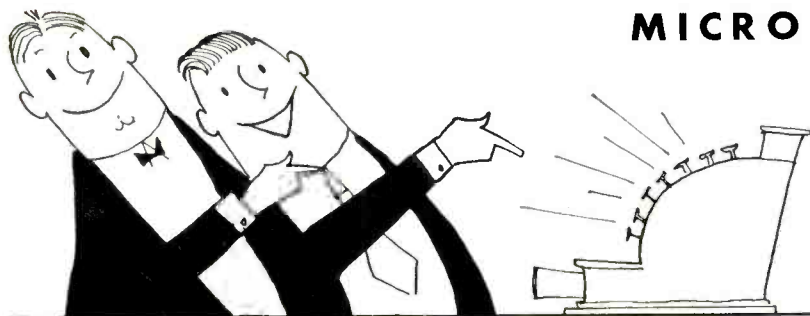

"Columbia," "Masterworks" and  Trade Marks Reg. U. S. Pat. Off. Marcas Registradas  Trade Mark

# MAKE DISC SALES



## RCA VICTOR

This is the month RCA Victor introduces its new 45 RPM record playing system to the public, so dealers will obviously stress 45 RPM to their customers.

Initial release schedules call for approximately 143 Red Seal classics, with a variety of "pop" classics, popular songs, country and Western, blues and rhythm, international and children's records to be available.

Shellac albums of especial interest this month include: Jascha Heifetz playing the Beethoven "Spring" Sonata (DM-1283); pianist Vladimir Horowitz' interpretation of the classic "Sonata No. 12 in F" by Mozart (DM-1284); and Kabalevsky's Sonata No. 3, Op. 46" (DM-1282). Singles by Licia Albanese and Marian Anderson are also worthy of mention.

◀ 45 RPM records and equipment in use.



## COLUMBIA

In a letter to distributors, Columbia Records executives stressed the fact that the Columbia catalog abounds in superb music for Easter in both Masterworks and popular records. A special Easter hanger has been prepared for dealer use. Available on LP records are the following appropriate selections: Handel's "The Messiah"; "A Choral Concert," dePaur's Infantry Chorus; "Organ Music of Bach," E. Power Biggs; "Sacred Songs" by Helen Traubel; "Bless this House," Christopher Lynch; Rimsky-Korsakov's "Russian Easter Overture"; "Sacred Arias of Johann Sebastian Bach," Carol Brice.

Two Easter best-sellers: "Sacred Songs," by Helen Traubel (right) and the Christopher Lynch album shown below.



# BLOOM

# IN THE SPRING



## DECCA

The Bing Crosby album pictured is to be released concurrently with the film of the same name. Extensive dealer promotions are taking place. Advertising tie-ins, local previews, and point-of-sale display cards have been utilized to further publicize and push the album. Another Crosby classic is being born.

Decca's release of Ray Bolger doing the hit tunes from his show, "Where's Charley," is also selling well—"Once in Love with Amy" backed by "Make a Miracle," 40065.

Leading the Easter promotion is the Decca FFFR release of "St. Matthew Passion," Bach, (EDA 43) with excerpts by Kathleen Ferrier, contralto.



## MGM

Tie-in possibilities for the "Easter Parade" album, taken from the movie sound track are limitless. This collection contains some perennial all-time favorites.

A new record by MGM artist, Jack Kilty, called "Tulsa," is scheduled for a big build-up, tying in on a joint promotion with the movie "Tulsa." National exploitation is planned.



## CAPITOL

Kiddie album, shown at left, a natural for Easter children's presents.



Inset shows the new Capitol label for its recently acquired classical line of recordings, which are to be sold at \$1.50, \$1.25, and \$1.00, depending on the category. The first Telefunken release consists of five albums and four singles, they will be pressed on a superior type material to give a better sounding surface, but are not unbreakable.

RECORDED DIRECTLY FROM THE SOUND TRACK OF THE M-G-M TECHNICOLOR MUSICAL

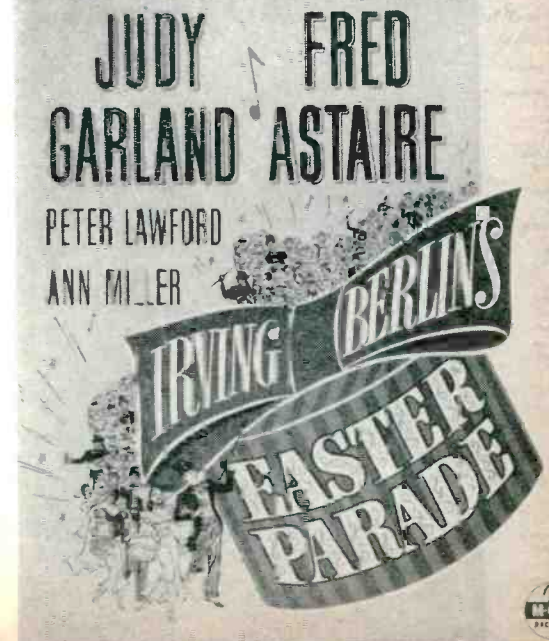

# RCA Victor's Record Playing System

(Continued from page 73)

In addition, the RCA Victor line will include the 45 RPM system in table model radio - phonographs, console radio-phonographs, and console combinations with television, radio and phonograph.

In a hand-out consumer booklet issued by RCA Victor titled, "What's the Idea . . . Behind RCA Victor's Record and Player," the following pointers are featured: new and finer system of recorded music; distortion-free record; modern, foolproof mechanism in miniature; records easily handled; one seven-inch size for both classical and popular; best quality; beautiful tone; trigger action changer; priced right.

When actually demonstrating the record, dealers should touch on each one of the aforementioned pointers. The rapidity of change on the player, reducing the lapse between the records, deserves comment. Customers should

be encouraged to handle the records, note the light weight, the sturdy non-breakable construction, the use of vinyl-plastic and resulting long wearing qualities. Stress should also be placed on the design of the records, with a center shoulder providing air space between each record, so that the playing surfaces do not touch while the records are on the changer or in storage.

Another eye-catching feature bound to impress prospects is the RCA Victor "color code." The black, blue, or the bright red, green, yellow, and cerise records are not only pleasant to look at, but permit collectors to segregate their libraries into categories by the simple means of color identification.

Comparing prices of RCA Victor's 45 RPM recordings with their shellac equivalents will prove to be another potent selling factor. The price comparison chart shown on this page should be prominently displayed in the store.

It should be made clear to purchasers of the new records and equipment that existing 78 RPM players are not obsolete. All recording companies have announced their intention of continuing to release 78 RPM recordings.

## Release Schedule

The initial April 1 release of 45 RPM discs is being followed by a popular release on April 15; the first regular popular release to come out simultaneously on both 78 and 45 RPM is planned for May 1; first Red Seal release to be issued simultaneously on both speeds is expected by June 1.

Dealers can do a good advertising job on their own to augment the national effort. In addition to the original window display, which was unveiled at the conclusion of the "teaser" campaign, a hard-hitting display can be planned to tie-in with the May issue of "Life" magazine, in which RCA Victor has planned a 4-color spread on 45 RPM.

Counter cards, booklets, mailing pieces, assorted window, door and counter streamers, record hangers, envelope stuffers with space for dealer imprint, and badges for salespeople calling attention to 45 RPM, are just a few of the other things placed at the dealer's disposal to help him do an all-out selling job.

As we have repeatedly stated throughout the present "3-speed" situation, the enterprising merchant can and will make money in the record business. Those 25 million turntables which it has been estimated will be in use by the end of 1949 will take a lot of records. And every new development in the industry gives dealers just that much more opportunity to cash in on the activity.

## Columbia Pop Releases

"Where Is the One" backed by "Bop! Goes My Heart," is title of new Frank Sinatra disc. It is available on shellac (38241) and on LP (1-154.) Sinatra has also waxed "Some Enchanted Evenings" — "Bali Ha'I" two very new ballads from the musical "South Pacific." These are also available on LP and shellac. (10"—38446; 7"—1-174.)

Dinah Shore's rendition of "Havin' a Wonderful Wish" teamed with "The Story of My Life" should be another top favorite for this vocalist. (10"—38422; 7"—1-155). Miss Shore's radio show has proved to be a good pulling card in her favor.

## Decca Radio Show

Decca Records, Inc., New York City, has announced that its experiments in recording over FM station WABF, in New York, was undertaken in an effort to expand the selection of recorded material heard on Frequency Modulation programs. Jack Kapp, president of Decca says "We intend to make full use of the entire Decca catalog to encourage enlarging of the FM scope in the presentation of recorded material."

## RCA Victor "Review"

RCA Victor's new publication, the "RCA Victor Record Review," combined with "In the Groove," made its debut in a completely new format. Featuring modern typography and makeup, issues feature both popular and Red Seal personalities and music.

## Concert Hall Records

Concert Hall Society, 250 W. 57th St., New York City, has released two works out of its repertoire on twelve-inch microgroove plastic discs, to be played at a speed of 33 $\frac{1}{3}$  revolutions per minute. The playing time of each record is up to approximately forty minutes. The selections are "The Four Seasons," by Antonio Vivaldi, and the "Violin Concerto" of Aram Khachaturian.

## Sign Artists to Contract

Eleanor Steber, Metropolitan Opera soprano, has signed with Columbia Records for a long-term pact, according to an announcement by Goddard Lieberman, vice-president in charge of the Masterworks Division. Mr. Lieberman also announced the signing of Artie Shaw, Mary Martin, Dennis Morgan, and Eva Gustavson to contracts. Columbia has added to its band roster the bop ensembles of Jerry Wald and Chubby Jackson, announced Manie Sacks, vice-president in charge of popular artists and repertoire.

## COMPARISON OF RCA VICTOR RECORD PRICES

<b>RED SEAL CLASSICAL SINGLES</b>	
45 RPM Single . . . . .	\$ .95
12" Vinyl Plastic Deluxe Single . . . . .	2.00
12" Shellac Type . . . . .	1.25

<b>RED SEAL ALBUMS</b>	
45 RPM	
2 Records . . . . .	\$ 2.20
3 Records . . . . .	3.35
4 Records . . . . .	4.30
5 Records . . . . .	5.25
12" Shellac Type	
2 Records . . . . .	\$3.50
3 Records . . . . .	4.75
4 Records . . . . .	6.00
5 Records . . . . .	7.25
12" Deluxe	
2 Records . . . . .	\$ 5.00
3 Records . . . . .	7.00
4 Records . . . . .	9.00
5 Records . . . . .	11.00

<b>SINGLES</b>	
Popular, etc.	
45 RPM . . . . .	\$ .65
10" Shellac . . . . .	.75
12" Shellac . . . . .	1.00
Children's	
45 RPM . . . . .	\$ .65
10" Non-breakable . . . . .	1.00

<b>ALBUMS</b>	
Popular	
45 RPM (3 records) . . . . .	\$2.30
10" Shellac type (3 records) . . . . .	3.25
Children's	
45 RPM (2 records) . . . . .	\$1.50
10" Non-breakable (2 records) . . . . .	2.25

(Prices of 10 and 12 inch singles and children's albums, and all 45 RPM prices do not include Federal Excise Tax.)



# Names that make you money...

IN  
YOUR  
NEW  
**RCA VICTOR**  
**RED SEAL**  
RELEASE FOR MAY

## Licia Albanese

**ADRIANA LECOUVREUR:** (Act 1) Io Son L'umile Ancella—Cilea. **DON GIOVANNI:** (Act 1) Batti, Batti, O Bel Masetto—Mozart. With RCA Victor Orchestra. D. Marzollo, Conductor. Record 12-0658, \$1.25.

## Alexander Brailowsky

**JEUX D'EAU**—Ravel. **IMPROMPTU No. 2 IN F MINOR**—Fauré. Record 12-0794, \$1.25.

## Marilyn Cotlow

**SLEEP, NOW**—Barber. **AT THE WELL**—Hageman. With Claire Stafford at the piano. Record 10-1467, \$1.

## Arthur Fiedler

Boston Pops Orchestra: **THE QUEEN OF SHEBA: BALLET MUSIC**—Goldmark. Record 12-0796, \$1.25.

## The First Piano Quartet

**MAGIC FIRE MUSIC**—Wagner. **RONDO IN D**—Mozart. Record 12-0766, \$1.25.

The world's greatest artists are

# on RCA VICTOR records

## Heifetz

**SONATA No. 8 IN C**—Mozart. **MENUET**—Mozart. DM-1290, \$2.50. (2-pocket container)

## Serge Koussevitzky

Boston Symphony Orchestra: **DON JUAN**, Op. 20—Richard Strauss. DM-1289, \$2.50. (2-pocket container)

## Pierre Monteux

San Francisco Symphony Orchestra: **POEME D'EXTASE**, Op. 54—Scriabin. DM-1270, \$2.50. (2-pocket container)

## Jan Peerce

**OH, PROMISE ME**—Scott. **SERENADE** (from "The Student Prince")—Romberg. With Orchestra and Chorus, Warner Bass, Conductor. Record 12-0795, \$1.25.

## Artur Rodzinski

Chicago Symphony Orchestra: **SYMPHONY No. 3 IN A MINOR**—Mendelssohn. DM-1285, \$6.00.

and

## Sir Thomas Beecham, Bart.

**THE GOLDEN SPINNING WHEEL**—Dvořák. DM-1291, \$4.75.

**CONCERTO FOR FLUTE AND HARP IN C**—Mozart. DM-1292, \$4.75.

**PRINTEMPS**—Debussy. DM-1293, \$2.50.

**THE BARTERED BRIDE**—Smetana. DM-1294.

**ORPHEUS**—Liszt. DM-1295, \$2.50.

**FAUST**—Gounod. DM-1300, \$11, and DM-1301, \$11.

### Reinstated in Catalog

**LEOPOLD STOKOWSKI** with the Philadelphia Orchestra: **Gurre-Lieder**—Schönberg. DM-127, \$18.50.

**BAYOU BALLADS OF LOUISIANA PLANTATION**. Sung in Creole by Marguerite Castellanos Taggart. With Edno McLaughlin at the piano. MO-728, \$4.

All prices are suggested list, subject to change without notice, exclusive of local taxes. Prices of single records do not include Federal Excise tax. DM albums also available in manual sequence, \$1 extra.

**TELL YOUR CUSTOMERS . . .** that all the new 45 RPM releases (for RCA Victor's New System of Recorded Music) will also be available on 78 RPM (for regular-speed players). As in the past, RCA Victor will continue to serve your 78 RPM customers with all new releases!



# LP FLASH!

Alliance Announces . . .

## TWO New Record Players!

Why Worry About Which Speed?  
End Your LP Problems with  
these two Alliance **FIRSTS!**

### NEW—

**Dual-Speed 33 1/3 and 45 r.p.m. Record Player** (Model J.P.D.) combines both new slower speeds in one single player unit, complete with motor and turntable. Ideal as a single player; it can also be adapted to record changers!

### NEW—

**Single-play 45 r.p.m. Record Player** (Model J.P. 45) expressly for the new 45 r.p.m. records . . . a complete motor and turntable assembly.

Starting on March 1st, Alliance announces mass production on both new models! Like all other Alliance Phonomotors, they are built and engineered for long life and trouble-free operation.

**Retailers, Service Repair Shops and Retail Service Dealers** can order the new Alliance LP players from their regular jobber. Both players come individually boxed—make ideal units for conversion work and for resale to customers.

Meet the rapidly growing demand caused by the popular trend to the new record speeds by ordering Alliance players from your jobber—**NOW!**

## alliance motors

ALLIANCE MANUFACTURING COMPANY • ALLIANCE, OHIO  
Export Department; 401 Broadway, New York, N. Y., U. S. A.

### PRINT YOUR OWN POST CARDS

COMPLETE OUTFIT  
only \$7.50

Amazing results in sales, inquiries and contacts . . . saves time and money . . . very easy to use. **GEM STENCIL DUPLICATOR** is ideal for Advertising, Announcements, Notices, Labels, Forms, Price Lists—hundreds of uses for every type of business and organization. Comes complete with all supplies, instructions and 60-page Book of Ideas.

**FREE TRIAL OFFER:** Try it before you buy it! Write and a GEM OUTFIT will be sent you postpaid. After 10 days, send only \$7.50 or return the GEM, no questions asked. The GEM must sell itself; you be the judge.

**BOND EQUIPMENT CO.** DEPT. 125 — 6633 Enright  
St. Louis 5, Mo.

SEND NO MONEY • FREE TRIAL OFFER

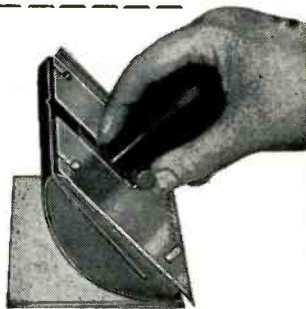

## New TV Products

### Anchor TV TUBE SLEEVE

Because the high second anode voltage is present over the entire cone of the new metal TV picture tubes, this plastic sleeve has been designed to facilitate mounting

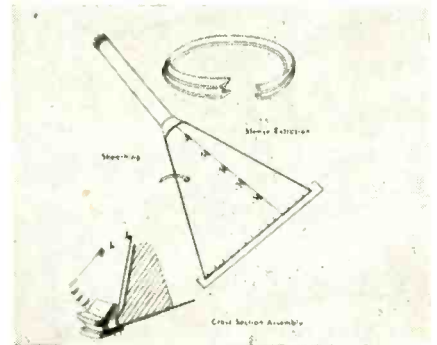

and insulating the tubes. All metal portions of the tube are covered by the plastic sheathing and the extruded plastic mounting ring, which covers the rim. Anchor Plastics Co., 533 Canal St., New York, N. Y.—RADIO & TELEVISION RETAILING.

### Guthman TV TUNER

This TV front end, said to be an improvement over earlier types, is available to set builders, experimenters and assemblers of television kits. The unit can also be used as a remote control tuner through the use of an accessory converter transformer. The tuner has three tubes, with tuned input, adjustable slug tuning and vernier for fine tuning. List for factory pre-aligned tuner is \$75. Guthman International Corp., 75 West St., New York 6, N. Y.—RADIO & TELEVISION RETAILING.

### Spellman TV PROJECTION LENS

This f/1.9 projection lens is designed for use with the 5TP4 projection tube to project pictures up to 7 x 9 feet in area.



Mounting barrel provided which fits against the face of the tube. For additional information write Spellman Television Co., Inc., 130 West 24th St., New York 11, N. Y.

### Transvision TV COMPONENTS

Photos, diagrams, and ratings of 19 TV components, including transformers (power, video, audio, and sync), yokes, focus coils, etc., are available in the Transvision Television Components Folder No. P-1, which may be had on request from Transvision, Inc., 460 North Ave., New Rochelle, N. Y.—RADIO & TELEVISION RETAILING.

**SRO**

**has a  
new meaning  
now!**

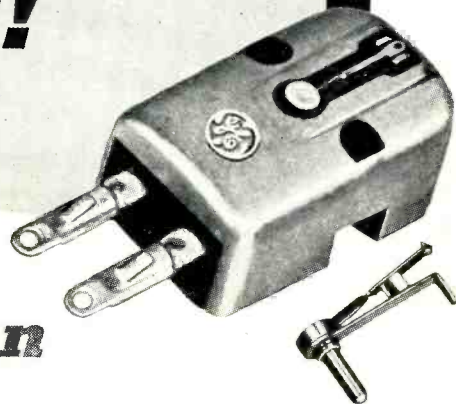

## Stylus Replacement Often

WHEN the big attraction hit town they hung the "Standing Room Only" sign—it meant overflow business.

It still means that, but the big attraction now drawing overflow business for distributors and dealers is the G-E Variable Reluctance Cartridge with the Replaceable Stylus.

Why? Because record fans who know their records best wanted the finest reproduction possible. The G-E Variable Reluctance Cartridge gave them just that. To secure peak performance they often replaced the cartridge when the stylus was only slightly worn.

Now, with the Replaceable Stylus, cartridge replacement is no longer necessary. In four easy steps the cartridge can be removed from the tone arm, the stylus changed and listening pleasure increased.

Economy is the big feature but this redesigned cartridge has many other advantages. Smaller in size, it can be adapted to many

more tone arms. Higher lateral compliance provides more faithful tracking, hence better fidelity. Frequent stylus replacement reduces record wear and adds hours of top listening pleasure. Needle talk and needle scratch are negligible, giving cleaner, finer reproduction.

Best of all, the cartridge is available for either the new LP records with 1 mil stylus or for conventional records with the 3 mil stylus.

Now for the *Big Extra* to step up sales! A neat dispensing unit for the counter with two cartridges and six stylii recessed in a gold-flocked panel to catch the eye. The entire unit is finished in an attractive blue and has a compartment in the rear for additional stock. It is a silent salesman that keeps selling. See your distributor right away for details.

For complete information on Variable Reluctance Cartridges and Replaceable Stylii write to: *General Electric Company, Electronics Park, Syracuse, New York.*



The counter sized dispensing unit for greater sales—7¾" long, 5½" wide, 4¾" high at the back.

*You can put your confidence in—*

**GENERAL**  **ELECTRIC**

**TITONE**

**Now! A \$10 SALE**  
for every record-player in your area!

LIST PRICE \$7.50

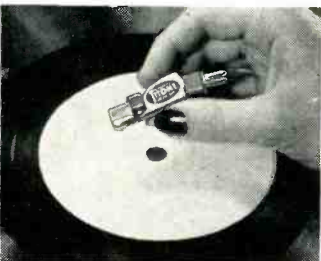

**SELL NEW TITONE PICKUP to every customer!**

Here's a way to quick profit from every player owner who visits your shop! Have your salesmen "plug" it on every service call! First basic pickup advance in over 10 years—the original piezoelectric ceramic pickup, made by SONOTONE, famous makers of hearing aids and miniature tubes!

- SELLS ITSELF IN A 2-TO-5-MINUTE CALL! Fits all tone arms. Let all your customers hear TITONE. They'll say "SOLD!" because—
- TRANSCRIPTION TONE QUALITY! Full frequency to 10,000 cycles! Real high fidelity! Bell-like supertone makes even old players thrilling!
- SURE-FIRE IN HUMID CLIMATES! Utterly unaffected by climate, moisture, fungus! Booms sales, wins back customers.
- DOUBLES RECORD LIFE AND PLEASURE! Gives "ordinary" records sparkling quality—revives worn favorites. Will play down to 1/2 normal pressure. NO "needle talk"!
- RUGGED! PERMANENT! No crystals, magnets, filaments to fail! No pre-amplifiers. Ceramic TITONE performs perfectly for years!

NO TONE LIKE  
**TITONE**  
CALL YOUR JOBBER—  
or write now to  
SONOTONE, Box T-1, Elmsford, N. Y.

**picks up profit NOW!**

# Comments on the Present UHF Controversy

## Zenith

H. C. Bonfig, vice-president of Zenith, made a statement to the RMA, during their annual meeting at Chicago. He said in part: "There is an acute shortage of television channels which can be relieved only by the addition of many new high frequency channels."  
"The FCC has repeatedly stated that a nationwide competitive television system cannot be built on the present 12 channels and that development of such a system will require the ultra high frequencies it has set aside for television."  
"On January 25, 1949, FCC Chairman Wayne Coy told the Radio Executives Club of Boston in regard to the total number of channels needed to have a nationwide competitive system 'my present thinking is that 50 to 70 channels may be required.'  
"By our arithmetic this means that from 38 to 58 new UHF channels may be required in addition to the 12 VHF channels now in use . . . In the public interest, every manufacturer should move rapidly to provide sets which will operate on both the old and the new television channels. We know it can be done. As we are doing it, others can do it too. . . . Since . . . changes and additions in frequencies and assignments have to be made, it is better for the public, the dealers and the industry that they be made now rather than wait until the public has purchased additional millions of television receivers that will tune only the present channels."

## General Electric

General Electric dealers handling the firm's TV sets have received a letter from W. M. Skillman, manager of sales, receiver division, stating among other things concerning the UHF situation that "Any prediction of commercially acceptable broadcast service within two years is highly improbable." The statement said that while ultra high frequency receiver development was well developed at the firm's laboratories, "we consider it unsound and extremely hazardous to make any releases until we clear on two important points," the latter being explained as further word from FCC on rulings covering the extent to which UHF bands would be allocated for such service, and the knowledge that no changes in present standards would be required. "Until such basic factors are determined," the statement goes on, "no manufacturer can build a set that could be offered to the public with the necessary assurance that it would fully meet the standard and perform satisfactorily 12, 18 or 24 months in the future. We believe that any television receiver designed for UHF reception must receive all of the proposed channels and not be limited to a specific number. Also that, it must be capable of this function without major modifications at a later date."

## Philco

UHF propagation tests by Philco engineers indicate that commercial UHF television, now under consideration by the FCC, "is unlikely for several years and when it does come will not obsolete present television sets," it was stated by David B. Smith, vice-president, research and engineering, Philco Corporation, under whose direction the tests were made.  
Excerpts from an official statement follow: "Philco tests of UHF television reception were made at 60 locations in the area of Washington, D.C., at distances from 1.5 to 23 miles from an experimental UHF station operating in the frequency channel from 504 to 510 megacycles. Results showed major advantages and disadvantages of television service in the UHF band.  
"It is considered probable that it will take at least three years or longer to develop com-

mercial UHF television transmitters with the power output shown to be necessary by the Philco investigation."

## Du Mont

Dr. Allen B. Du Mont, president of Du Mont Laboratories, Inc., speaking in New York, denied that present TV sets would be made obsolete if some of the video channels were to be moved into ultra high frequency bands. He said: "I feel that no change will be made in the present frequency allocations or standards and that just as the sets we made in 1938 are still in use, so the sets made today will be in use in 1959 and 1969. Additions may be made to our present channels, but they must and will be made with the protection of the public foremost in mind."  
Dr. Du Mont, in commenting on the statement made by Senator Edwin C. Johnson, of Colorado, that present television sets would be obsolete by the end of the year, said it was one of many in the history of the industry "made with an effort to confuse the public."

## Sightmaster

The following statement was made by Michael L. Kaplan, president of Sightmaster Corporation, New York, who is the originator of a movement to form a TV set manufacturers association: "My feeling in this UHF controversy is that a real injury has been done the entire industry by one manufacturer. There is nothing at present that warrants any owner of a television set to be perturbed about these UHF channels. They are still in the realm of possibility. There has been no transmitting equipment built today that will handle the UHF frequencies. There is still a vast amount of experimentation and field testing to be done before the UHF channels become practical realities. In my opinion, this is still two years away. When and if these UHF channels are made available, adapters would be obtainable that could be attached to any existing set. It is obvious to those of us in the industry that what precipitated this controversy is the result of manufacturer whose sets were late coming in the television market, having produced a receiver that 'laid an egg' in the trade, and now finds it necessary to pull all stops in an attempt to get his product sold. The agitation is unfortunate and unwarranted, and will retard the forward movement of the greatest new development in this country."

## Admiral

Ross D. Siragusa, president, Admiral Corporation, says in a statement to dealers: "Many dealers are gravely concerned as to how they might be affected by recent advertising, in which one television manufacturer claims that has product—and his alone—has qualities which are so unique, that only this one brand can resist obsolescence which might be caused by possible future developments in the ultra-high frequency field.  
"Flamboyant advertising claims and unstable predictions concerning the future, are a heritage of every great new industry. These often cause aches and dislocations, which for a day might appear to be serious ailments—but which in the main, prove to be nothing more critical than good old-fashioned growing pains.  
" . . . I say to you in all honesty and good faith, that Admiral television receivers are in no more danger of becoming obsolete than any other make on the market, and I, for one, do not believe that any well engineered standard make faces such a threat in the foreseeable future. I pledge to you and to the public, that no expense nor effort will be spared to keep Admiral Products in this position."

**FOR THE FIRST TIME—**

## **A Combination 78—33 $\frac{1}{3}$ —45 RPM Turntable Designed for High Fidelity Reproduction**

# Presto

**UNIVERSAL MASTER  
(TYPE 15)**



### **PRESTO TYPE 15**

#### **CHECK THESE EXCLUSIVE ADVANTAGES**

- ... Superior speed regulation—minimum wow and flutter.
- ... Turntable noise well below signal.
- ... No rumble from blank grooves or low-volume portion of records.
- ... High-quality pickups with permanent sapphire stylus—microgroove and standard.
- ... Handsome walnut veneer cabinet, enameled and lacquered brass metal.
- ... Heavy cast aluminum turntable, precision machined, dynamically balanced.

**Y**ES, for the first time, a combination microgroove and standard turntable with performance equal to the finest broadcast transcription turntables!

Takes records up to 12-inch diameter and operates at all three speeds—78 rpm (standard), 33 $\frac{1}{3}$  rpm (Columbia LP type) and 45 rpm (RCA Victor microgroove type).

Presto Universal Master answers all mechanical problems of record reproduction because it is a precision instrument—the only one of its kind on the market. Variations in types of grooves, turntable speeds, record shapes and sizes—all the factors that complicate the use of new-type microgroove turntables—are forgotten when you use this superior turntable.

For better reproduction, for longer trouble-free life, order Presto Universal Master from your jobber today. It's a *must* for optimum reproduction of microgroove or standard recordings!



**PRESTO**

**RECORDING CORPORATION**

Paramus, New Jersey

Mailing Address: P. O. Box 500, Hackensack, N. J.

In Canada: WALTER P. DOWNS, Ltd., Dominion Sq. Bldg., Montreal

*WORLD'S LARGEST MANUFACTURER OF INSTANTANEOUS SOUND RECORDING EQUIPMENT AND DISCS*



She'll say **YES, YES**  
to your **washer line**

**YES!** ...if you feature appliance lines that people want — nationally advertised lines — THE LINES DISTRIBUTED BY **Graybar**

**YES!** ... if you use good selling methods — modern merchandising and promotion tools — THE SALES HELPS AVAILABLE FROM YOUR LOCAL **Graybar** APPLIANCE SPECIALIST.

Yes, and you'll get prompt deliveries from a Graybar warehouse near you.

These are a few reasons why thousands of dealers throughout the nation make Graybar their No. 1 source of electrical appliances.

4927

Appliance Department  
**GRAYBAR ELECTRIC COMPANY, Inc.**  
Executive Offices:  
Graybar Building, New York 17

**THEY SAY YES WHEN YOU FEATURE APPLIANCES ... recommended by**  
**Graybar**

IN OVER 100 PRINCIPAL CITIES

RADIO & TELEVISION RETAILING • April, 1949

# ELECTRICAL APPLIANCES

Section of **RADIO & TELEVISION RETAILING**

## Show-Place Store Sells More!

*Hoosier Merchant Makes Modernization Project Pay*

"How can I sell more kitchen appliances, and more of them at one time?"

Jimmie Morrow (as he is familiarly known in Connersville, Indiana) asked himself this question some time ago. He mentally wrestled with possible solutions more than overnight, too.

Last year he rolled up his sleeves, ready with an answer. He went about building one of the most beautifully modern small stores in his part of the country, with emphasis placed on showing off the "woman's castle" within her home—the kitchen.

"The store cost about \$12,000," he stated, "and the increase in sales, especially of completely outfitted kitchens, has thoroughly justified the investment."

The new Morrow store embodies the central idea of visually pulling in traffic, showing off new appliances (all visible from the sidewalk) in an in-



A show-place, specifically designed for elaborate displays of appliances and complete kitchens, is the new Jimmie Morrow's store in Connersville, Ind.



Morrow operates a "live" automatic Frigidaire washer as prospect whets buying appetite.

ving bright setting—and follows up with installed kitchen appliances, demonstrable at the sign of a gleam in milady's eye!

During the first day of a two-day opening, Morrow clocked some 2800 "visitors" before the afternoon was very old. He wisely undertook registration of all comers.

"The 'live' kitchen appliances, backed up by our eye-catching American Kitchens installations, were the most popular items for the crowds," stated Morrow. "Washer, dryer, ironer, range, refrigerator—all were working overtime; and running water in the American Kitchens sink, with garbage disposer in place, gained continuous interest."

During the weeks following the open-

ing, customers continued coming into Jimmie Morrow's (incidentally, that's the store name) and the sales record for his 19 years of appliance retailing, reached by Christmas, has not dimmed the unusually high sales totals entering the books week after week in '49.

"Given an attractive store to start work with," Jimmie said, "we proceed on the theme that we can show customers how everything works, right here in the store. That's the big thing—don't say 'this refrigerator has easily changed shelving,' but show her; don't say 'you can turn this faucet on with your little finger, your hands full otherwise,' but show her; and when you are talking about wash-day leisure and ease, sit her down beside an automatic

(Continued on page 90)

# BIGGER AND BETTER...



**OPEN:**  
A MORE PRACTICAL RANGE



Here you have it—terrific selling power built into an intermediate-priced electric range. Never before have you had a feature like Universal's built-in concealed "Stor-O-Cabinet" with baked enamel, roller-mounted smooth-sliding drawers. Now you can offer balanced-front design at a low price.

And there's never been anything to equal Universal's Control-O-Matic Cooking... for better automatic cooking convenience... faster cooking speed... better control... and better baking results with Universal's large, flood-lighted Tru-Bake Oven.

For the hard-hitting competitive selling ahead, see...compare...feature this sensational new Universal Speedliner.

**BETTER FROM EVERY ANGLE!**  
**CONTROL-O-MATIC COOKING**  
in a  
**NEW UNIVERSAL ELECTRIC RANGE**

**WITH SENSATIONAL STOR-O-CABINET FEATURE**



AVAILABLE WITH LAMP AND TIME CONTROL AT SMALL ADDITIONAL CHARGE

**ONE MORE STEP IN UNIVERSAL'S GIGANTIC "PLANNED-PROFIT" PROGRAM FOR '49**



**CLOSED:**  
A BETTER LOOKING RANGE

## A RANGE AND WATER HEATER MODEL FOR



TWO OVEN RANGE



HEATER-END RANGE



PRICE LEADER RANGE



APARTMENT RANGE



BANTAM RANGE



# SALES BUILDERS FOR '49

*NEW FROM EVERY VIEW!*  
**Sensational New UNIVERSAL Automatic**  
*TEMP-O-STAT*  
**WATER HEATER**

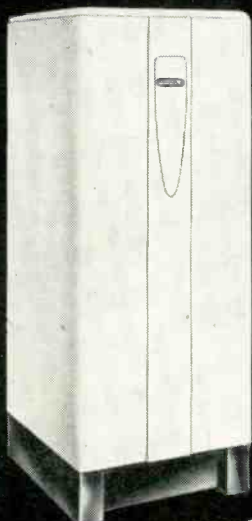

Inside and out, this revolutionary TEMP-O-STAT Water Heater is new... better. There's new security in its sensational Super-Safety Control that cuts off the flow of heat instantly should the temperature become excessive. New economy in its Super-Heat Immersion Element and corrosion-preventing Anodic Rod. New beauty, too, in every line of its design. Square. Round and Table Top Models... widest selection of types and sizes.

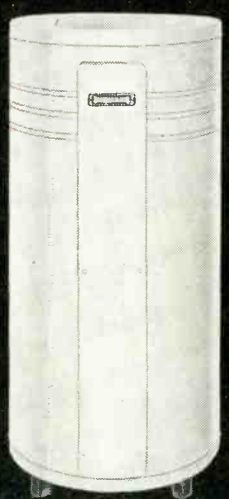

**EVERY PURSE AND PURPOSE**



# UNIVERSAL

LANDERS, FRARY & CLARK • NEW BRITAIN, CONN.

**PLUS** UNIVERSAL'S TREMENDOUS "PLANNED-PROFIT" PROMOTION PROGRAM

Yes, the most powerful advertising in Universal Range history! Big-space ads in Better Homes & Gardens, Farm Journal, Household, Small Homes Guide, Sunset and other top magazines covering all markets... coast-to-coast radio audience shows week-after-week... and powerful point-of-sale "Blitz" promotions with big dealer listing newspaper ads. Tie in your store today!



**SEE YOUR UNIVERSAL DISTRIBUTOR OR MAIL THIS COUPON TO US TODAY!**

Landers, Frary & Clark  
 New Britain, Connecticut  
 Dept. R-RT

I would like to have the complete story on your Spring "Planned-Profit" Range Program.

Store \_\_\_\_\_  
 Name \_\_\_\_\_  
 Street \_\_\_\_\_  
 City \_\_\_\_\_ Zone \_\_\_\_\_ State \_\_\_\_\_

# New Electrical

## Universal COFFEEMATIC

8-cup Coffeematic features "flavor-selector", which brews coffee to pre-selected strength of mild, medium or strong. A red signal-light automatically indicates when the coffee is ready to serve and remains on until unit is disconnected. Wider glass



top can be easily removed from the cap for cleaning; Universal "cold-water" pump starts percolation quickly and makes coffee without boiling; filter cup another feature. Coffeematic designed with a Platina Panel and finished in gleaming chrome; mottled mahogany bakelite handle; 6 ft. cord. Body and handle scientifically balanced to eliminate wrist strain; non-drip spout. Priced at \$24.95. Landers, Frary & Clark, New Britain, Conn.—RADIO & TELEVISION RETAILING.

## Youngstown CABINET SINKS

42-inch standard model cabinet sink, designed as a low-cost unit, has single bowl and drainboard; faucet assembly, rinsing spray attachment; one large compartment makes up the undersink. 36 inches high, 24 inches front to back.

Deluxe 42-inch model sink has single bowl and drainboard. Equipped with rinsing spray, crumb cup strainer; two drawers, one of which has a lined cutlery section, and two compartments in the undersink cabinet provide storage space. 36 inches high, 24 inches front to back. Mullins Mfg. Corp., Warren, O.—RADIO & TELEVISION RETAILING.

## Modern WATER SOFTENERS

Model MXR-A, combination softener and iron remover, softens hardest water, and filters out destructive and stain-forming iron, as well as sediment and suspended matter. Features single dial control valve controlling various steps in regenerating the softener. Unit also has a new type distributor system. Model BTR-A identical, except it is furnished with synthetic white zeolite, which has somewhat less softening capacity. Modern Water Equipment Co., W. Chicago, Ill.—RADIO & TELEVISION RETAILING.

## Westinghouse RANGE, REFRIGERATOR

Deluxe refrigerators come in 9 cu. ft. and 11 cu. ft. size.

Both models have 1 cu. ft. freezers and feature automatic control for maintaining cold in the freezer and steady temperatures in the main food compartment. L-shaped baffle under the freezer keeps excess cold air from spilling down into main compartment. Temperature bulb mounted outside of freezer responsive to needs of both compartments. Flexible shelving, new curved plastic breaker strips, two Humidrawers and a meat keeper are other features.

Double oven "Commander" electric range insures even broiling to all parts of the meat. The new broiler is also utilized in other models. Commander has four Corox heating units on the left side of the steel platform; features toe space flush with the body of the range. Ovens have a balanced heat principle which distributes heat evenly no matter what the rack positions are. Westinghouse Electric Corp., Appliance Div., Mansfield, O.—RADIO & TELEVISION RETAILING.

## Toastmaster WATER HEATERS

Standard model line of water heaters has been redesigned. Standard model tank and shell have been made lower and wider, to permit installation in limited space. Constructed in two pieces, base is rectangular with openings at both front

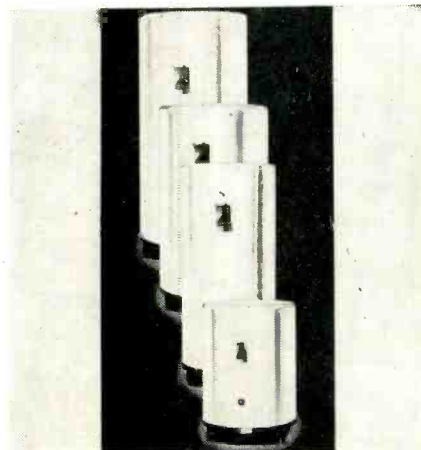

and back to make plumbing connections accessible. Electrical outlet moved to position high on back of shell. Top has been rounded into smooth, unbroken crown surface. Water heaters available in 30, 50, 67, 82, 100, 125 and 150 gallon capacities. Ionodic Rod lengthened and centered in tank. Clark Div., McGraw Electric Co., Chicago, Ill.—RADIO & TELEVISION RETAILING.

## Juice King ORANGE JUICER

Orange juicer squeezes whole fruit. Combines speedy single-stroke action with ease of operation. Single-blade cutter-strainer does the juicing job. Priced at \$14.95. National Die Casting Co., Touhy Ave. at Lawndale, Chicago 45, Ill.—RADIO & TELEVISION RETAILING.

## Proctor IRON

Steam-dry iron shown, features heavier soleplate than the Proctor Never-Lift, and has steam vents and provision for water reservoir attachments. Can be changed from steam or dry iron by a flick of a



valve at the top of the water chamber, which is made of plastic and is filled through an opening at the top. Weight of the reservoir is 4 oz. Iron can be used as a dry iron with the reservoir on or off. Has aluminum soleplate; weighs about 4 lbs. Proctor Electric Co., Philadelphia, Pa.—RADIO & TELEVISION RETAILING.

## Surf AIR CIRCULATOR

Twenty-four-inch air circulator available in models for wall, floor, and table-top use, for industrial and commercial applications, as well as for use in the home. Features: New 1/4 H.P. induction motor; three speeds, with internal switch control; three separate air flow adjustments; chrome plated fan guard; new oscillating mechanism prevents fan from tipping over. Circulator consists of the motor, fan and the fan guard, which are packaged as one unit; available in a choice of two types of pedestals or stands, which are interchangeable on the fan unit. The high stand, for floor use, adjusts from 5 ft. to 8 ft. high. The low stand adapts the circulator to either counter or wall use. The floor models list at \$124.50. The counter or wall model with low stand lists for \$107.00. G-M Laboratories, Inc., 4300 North Knox Ave., Chicago, Ill.—RADIO & TELEVISION RETAILING.

## Pureaire KITCHEN

Complete kitchen unit, complete with refrigerator, range, oven, sink, shelves and drawers. Dimensions: 48 inches wide, 34 inches high, 24 inches deep. Two-piece construction for ease of handling and installation. Ventilation designed and engineered to remove cooking odors and heat through outside vent. Electric oven is 16 x 16 x 16 inches; electric range has 3 tubular range surface units (Gas oven and range also available.) The Parsons Co., Traverse City, Mich.—RADIO & TELEVISION RETAILING.

# Home Appliances

## Amana FREEZER

Model 50, 42 $\frac{5}{32}$  inches high, 31 $\frac{1}{4}$  inches wide, 26 inches deep. Unit has capacity of 5 cu. ft. Chest type style, with easy opening lid. Zero wall coil construction; Fiberglass insulation. Finished in white Dulux enamel. Refrigeration Div., Amana Society, Amana, Iowa—RADIO & TELEVISION RETAILING.

## Everhot ROASTERETTE

Model 857 electric casserole roasterette, features cooking and serving in one unit. Retail for \$11.95. White, heat-resistant enamel exterior, cover of polished aluminum alloy; knob and handles of plastic. Equipped with removable inset pan and trivet for maximum convenience in cooking and cleaning. The Swartzbaugh Mfg. Co., Toledo, O.—RADIO & TELEVISION RETAILING.

## Camfield SILVER AUTOMATIC TOASTER

Toaster is a Sheffield reproduction of the Camfield blue ribbon toaster, designed with ebony black base and fittings to set off the silver. Comes in an antique treasure chest of oak with metal bands. Chest developed to meet demand of the luxury gift trade. Retail price is \$150.00, including federal luxury tax. Camfield Mfg. Co., Grand Haven, Mich.—RADIO & TELEVISION RETAILING.

## Fresh'nd-Aire FANETTE

Model 80, portable fan, known as the "Fanette," is styled in pastel green plastic and is portable. It measures less than 10 inches high, and is 9 inches wide and less

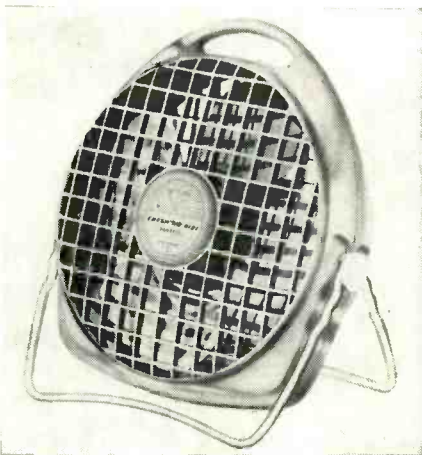

than 4 inches thick. Plastic housing is responsible for light weight. Weighs 3 lbs. Incorporates a handy carrying handle. U-shaped legs permits unit to stand without tipping. Retail for \$11.95. Fresh'nd-Aire Co., Division of Cory Corp., 221 North La Salle St., Chicago 1, Ill.—RADIO & TELEVISION RETAILING.

## Duo-Therm SPACE HEATER

Model is styled in the fashion of Chipendale furniture, finished in walnut brown. Rounded contours; low console appearance. Also featured are Duo-Therm dual chamber burner and power-air unit, which can be installed on either side of the heater. Duo-Therm Div., Motor Wheel Corp., Lansing, Mich.—RADIO & TELEVISION RETAILING.

## Universal FOOD MIXER

Food mixer, shown, comes complete with one and two-quart mixing bowls, juicer and strainer. Extra large stainless steel beaters do a better mixing job. Convenient beater release located at forward end of handle. Beater sockets are keyed so each beater



automatically inserts properly to avoid jamming. Light, detachable air cooled direct drive motor has 10 speeds with governor insuring full power at any speed. Power Guide Indicator aids in selecting correct speed for each mixing job. Streamlined appearance, with white enamel finish and blue trim. Landers, Frary & Clark, New Britain, Conn.—RADIO & TELEVISION RETAILING.

## Tracy SINK-CABINET

66-inch porcelain deluxe double bowl sink and cabinet unit includes double drainboard sink top in white, acid resisting porcelain enamel, fitted with crumb cup strainers, faucet with spray attachment. Unit is complete with undersink cabinet, recessed center section, stainless steel handles, insulated doors and drawers, concealed ventilation, extra storage space. Tracy Mfg. Co., Pittsburgh, Pa.—RADIO & TELEVISION RETAILING.

## Red Jacket SUBMERSIBLE PUMP

Red Jacket-Reda "Submerga-Pump" consists of a motor and pump combination that is close coupled and is installed into the well below the water level. Unit is installed out of sight; does not have to be protected from freezing. Entire unit cooled by a water jacket in the well. Unit weighs 75 lbs., and is supplied with a 120 ft. special two conductor submarine electric cable designed to resist moisture. Red Jacket Mfg. Co., Davenport, Iowa—RADIO & TELEVISION RETAILING.

## Hotpoint CLOTHES WASHER

Washer features single dial control for automatic operation combined with selection of quantity and temperature of water for large or small washday chores; stresses flexibility. Unit designed to "combine most



wanted features with economical hot water consumption in a machine to retail in the middle bracket." Hotpoint, Inc., 56—W. Taylor St., Chicago.—RADIO & TELEVISION RETAILING.

## Burgess VIBRA-SPRAYER

Electric sprayer features: removable 25 oz. mason type jar; extra nozzle discs; handle and finger-tip trigger control designed for comfort; sturdy storage carton. Sells for \$12.95 complete. Unit is lightweight, sprays enamel, lacquer, varnish, shellac, insecticides. Burgess Battery Co., Handicraft Div., Lake Zurich, Ill.—RADIO & TELEVISION RETAILING.

## Duchess WASHERS

Model 5M, 6 lb. dry clothes capacity with straight blades, high vane agitator. List price, \$99.95. Model 7M has a 23-inch diameter tub, capacity of 9 to 10 lbs. dry clothes, list price \$119.95. Model 9M has a 23-inch diameter tub, and a heat retaining jacket, 9 to 10 lbs. dry clothes capacity, list price \$139.95. All models equipped with Lovell wringers. Finish is white with pastel blue trim. Appliance Mfg. Co., Alliance, O.—RADIO & TELEVISION RETAILING.

New Radio Merchandise,  
pages 40, 65

Technical New Products  
pages 98, 100

# Show-Place Store Sells More!

(Continued from page 85)



Morrow's store interior looked like this on opening day. Improvements cost the dealer about \$12,000 and were well worth the sum spent. Well-planned lighting is a feature here.

Below, left, hundreds of prospective purchasers registered names and addresses at opening of the new store. Such visitors will be followed up; invited to coming cooking, laundering and economic classes. At right, Jimmie Morrow escorts a customer on a tour through the modern kitchen displays.



washer, and actually launder clothes while she rests.

"You accomplish a lot more with installed appliances, and a kitchen atmosphere with wall cabinets, sink and all."

But let's look a little closer at this modern-as-a-minute store:

It measures about 20 x 100 x 10 feet, and certainly the first thing that strikes you from the exterior is that you can see all the way back through the store because of the all-glass front and brilliant lighting throughout. Ceiling fluorescent units, 18 of them, parade in two lines toward the store rear, equipped with 4500-degree white bulbs.

Acoustical ceiling, light walls and rubber-tiled flooring are features. An electric eye door-opening mechanism is to be installed. Recessed, inside and outside, spot lights of 250 watts each make the window a showplace of its own. Glass brick trim at the window base, and glass brick counters in the store are also attractive.

And the whole front of the store, other than the glass, is glass tile and aluminum (the glass window itself angles to the glass door entrance). "Jimmie Morrow's" in raised glass tile letters shouts from over the show window out front.

"The place was dark and dingy before, and now it's the show place of the town," said Morrow. "But of course we aren't devoid of any other ideas. We've got a schedule of cooking and laundry schools, home economic group demonstrations, visiting consultants from Frigidaire and American Kitchens, and so forth.

"We mean to show them and sell," he concluded.

# SERVICE & SOUND

Section of **RADIO & TELEVISION RETAILING**

## Protelgram Installation, Service

Projection TV sets utilizing the Philips system may be considered as divided into two parts: the Protelgram unit, and the TV chassis. Servicing of the TV chassis will follow conventional practice and instructions of the manufacturer. An explanation of the optical principles of Protelgram appears elsewhere in this issue, along with pictures of some of the sets utilizing this system.

The Protelgram system consists of the following: the optical unit and the high voltage (25KV) unit. Associated mirrors and projection screen may be considered as part of the cabinet. The optical unit is a metal box containing a spherical mirror, an inclined mirror with an elliptical hole in the middle to admit the tube face, and a lens in the top which transmits the light to the viewing screen (this lens is known as the corrector lens). On one side of the box is an assembly known as the "tail piece" which consists of the yoke, focus

coil, optical focusing adjusting screws, and the 3NP4 projection kinescope. The tail piece fits into a hole in the side of the box and is held in place with four thumb screws.

The spherical mirror, inclined plane mirror and corrector lens are fitted at the factory and require no adjustments in the field. As a matter of fact, it is requested that these elements be left as is, and if they have any faults they should be returned to the factory.

The set for installation will be completely assembled except for installation of the 3NP4. This is accomplished as follows (relatively the same procedure would be followed in replacing the tube): in view 1 below, the optical box is viewed from one side, showing the tail-piece in position but without the tube. Loosen the 4 thumb-screws "M," rotate the tail-piece to the left and lift it out of the box. The focus coil is on the outside of the tail-piece, and the

yoke is on the inside. The tail-piece out of the box is shown in view 2. The tube is inserted in the yoke so that the 2nd anode cup will be facing down when replaced in the box. Attached to the end-plate (see view 1) is a clamp to hold the neck of the tube. This clamp is under the end-plate and is held in position by two screws "E." There is an additional screw on the clamp itself. Tighten the screw on the clamp to hold the neck in place, and tighten the two screws "E" so that the neck will be centered in the hole in the end-plate. The tube socket will then extend slightly beyond the end-plate.

Two springs on the yoke contact the aquadag coating of the 3NP4 to connect it to ground. The tail-piece with the tube in place is shown in view 3. The light shield is attached as shown in view 4, with a rubber band, which may also be utilized to hold the grounding  
(Continued on page 110)

Step-by-step installation of 3NP4 is explained above. View #5 shows completed installation, with high-voltage unit placed next to projection box.

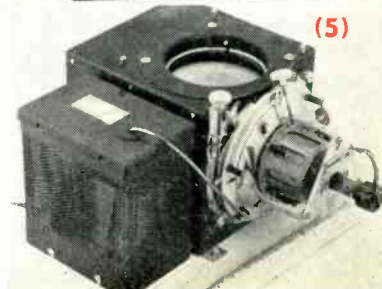
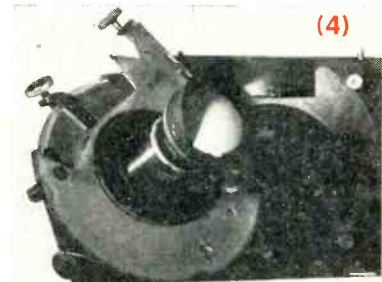
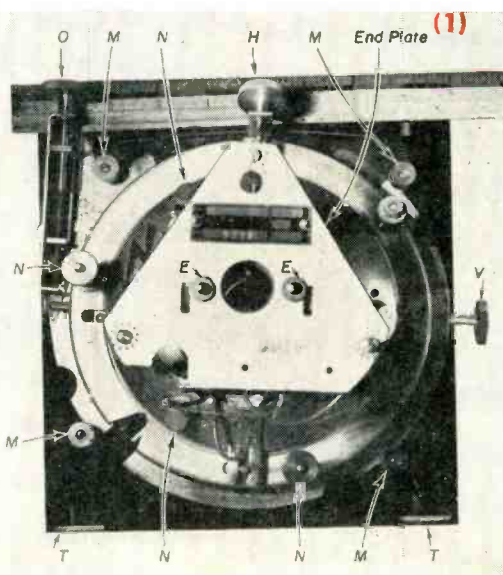
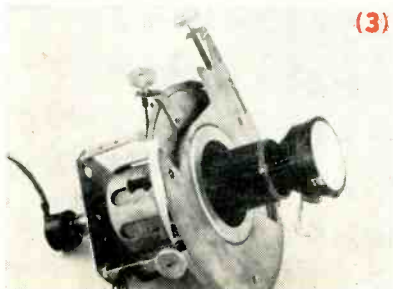
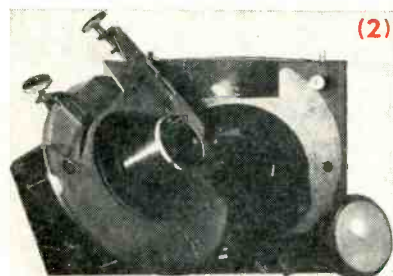

when **ALIGNMENT** is **BUILT-IN**  
trouble is built out!

NEWEST  
**Philmore**  
TELEVISION  
Pre-Aligned **KITS**

**ALL**  
COMPONENTS  
NOW  
**MOUNTED**  
by Philmore

Top view of completed chassis



and  
Channels are completely wired  
and

**Outstanding Features**

- ★ New WIDER Screen Television Offers BIGGER Pictures on All Size Tubes
- ★ 30 RCA Tubes (inc. Rect. and Video)
- ★ New Improved Daylight Viewing
- ★ Increased Voltage Power Pack
- ★ Simplified Step-by-Step Instructions
- ★ Six Full-Scale Litho Blueprints
- ★ Long Range Reception
- ★ Complete All-Channel Tuning
- ★ Ideal for Custom-Built Installations

Similar to  
famous **RCA**  
630TS and 830TS  
Circuits

DESIGNED FOR  
10"-12"-15"-16"  
PICTURE TUBES

When balance  
of simple wiring  
is completed, no  
further alignments  
are necessary

Jobber Inquiries Invited. For illustrated literature, write to

**Philmore** MANUFACTURING COMPANY, INC.  
Dept. RR-4 113 University Place, New York 3, N. Y.

**GE RADIO COMBINATION**

A single tone arm, with interchangeable pickup heads for playing both standard and long-playing records, is a feature of a new GE lowboy FM-AM radio-phonograph console. The set will be available in two models, 324-LP in mahogany and model 328-LP in American oak will both have eastern list prices of \$269.50. The record changer in the new console is automatic for 10- and 12-inch standard and long-playing records. Seven-inch long-playing records can be played manually. General Electric Co., Electronics Park, Syracuse, N.Y.—RADIO & TELEVISION RETAILING.

**Video TV SETS**

A new 135 square inch direct view table model television receiver listing at \$459.00 is now being scheduled for delivery by the Video Corporation of America, New York City. Additional models in the line now being delivered to dealers consist of a 91 square inch table model at \$359.00 and a 91 square inch television console with sliding door and hidden controls priced at \$499.00. Video Corporation of America, 229 W. 28th Street, New York City—RADIO & TELEVISION RETAILING.

**Emerson FM SET**

Model 602-C is a table model AC-DC FM set containing 7 tubes, with a slide rule dial. Retail price is \$29.95. Emerson Radio and Phonograph Corp., 111 8th Ave., New York, N. Y.—RADIO & TELEVISION RETAILING.

**Trans-Vue COMMERCIAL TV SETS**

The Trans-Vue system consists of one master timer and up to 10 remote-controlled television viewing units which can be placed in one or more rooms. Units were designed and engineered by the Raytheon-Belmont Corp. Remote viewing units come in two sizes, 77 and 134 square inches, both direct-view. For more information write Raytheon Manufacturing Co., 55 Chapel St., Newton 58, Mass.—RADIO & TELEVISION RETAILING.

**Industrial 5-WAY COMBINATION**

The I.T.I. Century model 321, is a five-way combination console with 72 square inch direct-view television screen, an AM-FM tuner, and a dual-speed record player. This unit, like the other Century models, features Industrial's simplified tuning. Tuning is done by the use of only two knobs, one for station selection and the other for contrast control. The Century 321 carries a retail price of \$695. plus installation in the New York area. Industrial Television, Inc., 359 Lexington Ave., Clifton, N. J.—RADIO & TELEVISION RETAILING.

**Telekit TABLE SET**

Kit 10-8 provides a 10-inch TV chassis for assembly, furnished with text, photos and diagrams said to simplify construction. Tuner is supplied factory-built and pre-aligned. Price of kit is \$99.50 less tubes. Tube kit lists for \$59.30, including picture tube, cabinet is \$24.50. Electro-Technical Industries, 1432 N. Broad St., Philadelphia 21, Penna.—RADIO & TELEVISION RETAILING.

### Symphonic RECORD PLAYER

Model 9 LP for playing LP microgroove records consists of a light-pressure tone arm, amplifier and 4-inch loudspeaker in walnut or mahogany cabinet, to list at \$29.95. Model 9 is similar, except that it plays 78 RPM records, and lists for \$19.95. Symphonic Radio and Electronic Corp., 292 Main St., Cambridge, Mass.—RADIO & TELEVISION RETAILING.

### American LP ATTACHMENT

This record player attachment is said to fit all existing types of record players for converting them to play LP microgroove records. Installation is not necessary for this unit, which consists of a speed-reducing turntable and a pickup arm. The turntable is placed on top of the existing turntable and removed when not in use. American Microphone Co., 370 S. Fair Oaks Ave., Pasadena 2, Calif.—RADIO & TELEVISION RETAILING.

### Microverter LP ADAPTER

Microverter is a device comprising a speed-reducing turntable and a light-weight pickup arm which converts many phonographs from single to dual speed. A switch is provided to switch back to 78 RPM. Microverter fits over the existing turntable, and installation instructions are provided. Microverter Inc., 53 Park Place, New York 7, N. Y.—RADIO & TELEVISION RETAILING.

### Telvar RECORD PLAYER

Smaller than the average portable record player, the new Telvar model P-20 includes the amplifier, speaker, 60 cycle AC electric phono motor and pickup. It is mounted in a two-toned leatherette covered case 11" x 12" x 6" weighing only 9 pounds and will play 12-inch records. Retail at \$24.95 including tax. Audar Inc., Argos, Ind.—RADIO & TELEVISION RETAILING.

### Challenger DISC RECORDER

Challenger Standard includes overhead feed mechanism and recording turntable capable of cutting records up to 13¼-inch diameter at either 78 or 33 RPM, playback arm which will accommodate 16-inch tran-



scription records, a 12-watt high fidelity amplifier and a full-range PM loudspeaker. Dealer's net is \$329.95 for the complete unit. Rek-o-cut Co., 38-01 Queens Blvd., Long Island City, N. Y.—RADIO & TELEVISION RETAILING.



## Checks all TELEVISION and Radio types SIMPSON 555 Tube Tester

- Basic RMA recommended circuit. Tests any tube regardless of base connections or internal connections of elements.
- Simpson designed 3-position lever operated toggle switches with molded rotor carrying silver plated contacts, self-cleaning through wiping action.
- Sockets for all receiving tubes on the market.
- Provision for future tube developments.
- No adapters or special sockets required.
- Properly fused, provides for line adjustment from 100 to 130 volts; smooth vernier control.
- Beautiful modern panel of shining silver and black anodized enduring aluminum.
- Large illuminated meter for easy readings.
- Unique jewel-like molded lucite housing encloses Neon bulb indicating shorts and inter-element leakages.
- Line adjustment control below dial opening. Easy to operate.
- Case of sturdy plywood with heavy fabricoid covering, slip hinges.
- Simpson patented "No-Backlash" Roll Chart.

SIZE: 16¾" Wide x 12½" High x 6" Deep  
Dealer's Net Price, with Operator's Manual . . . \$79.50

**Simpson**  
INSTRUMENTS THAT STAY ACCURATE



5200-18 W. Kinzie Street, Chicago 44, Illinois  
In Canada: Bach-Simpson Ltd., London, Ontario

See the 555 at your parts jobber or write for descriptive literature.

# LP\* Record Changers

The second in a series of articles by

Colin B. Dale, Director of Research, The Webster-Chicago Corp.

Part 1, which appeared in March, covered records, needles, needle pressures, and tone arm design.

## Part 2—Tripping Mechanisms

It is necessary to "trip" a record changer to make it operate, i. e., to go into the change cycle and place a new record into playing position, with the tone arm in the starting groove.

This "tripping" when done automatically is motivated by the record groove pushing the needle and tone arm.

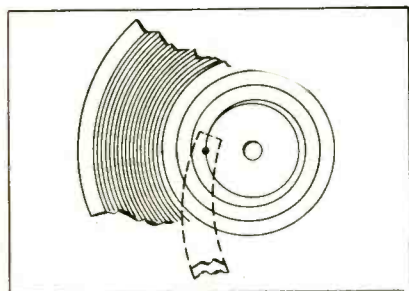

Figure 11: showing needle in eccentric tripping groove.

There are three major classes of trip systems in use on record changers, as follows: 1—Position trip—where the needle rides the innermost groove to actuate, through mechanisms below the frame, either an electrical contact or a mechanical device to start the change cycle.

While the position type of trip is simple, from the standpoint of size and number of parts, it has three disadvantages: First, the needle must ride the entire length of the unmodulated fast spiral groove before the trip action takes place. This results in an appreciable length of music silence before change cycle starts. Second, records having a diameter of inner groove larger than standard cannot be changed automatically. Third, the side needle pressure required to operate these trips may be greater than the micro-groove records and needles can stand without damage and skipping of grooves.

2—Ratchet or oscillating trip: where the needle rides in the eccentric groove for one or more revolutions, pushing the tone arm outward from the record center, to actuate a reverse ratchet mechanism below the frame. On some models, one outward stroke is sufficient. On others, the outward stroke is accumulative, i. e., if the first stroke is not sufficient, another one or two may be necessary before the cycle starts.

The one advantage of this type of trip over the position type, is that records having a larger diameter inner eccen-

tric groove can be changed automatically. Otherwise, the disadvantages are similar to those noted under one and three of the position trip.

3—Velocity or fast motion trip: where the tripping action takes place within less than the first revolution of the unmodulated wide spiral groove. The obvious advantages are: 1) the non-music time is reduced to a minimum, 2) the trip will change records having eccentric grooves of any diameter, 3) will also change records with a concentric inner groove, 4) the power required to operate the trip (i. e., the side pressure on the needle) will be at an absolute minimum (if the trip is properly designed). This is an absolute essential for the successful playing of LP records, requiring low needle pressures.

In the design† as developed by the Webster-Chicago Corporation, the velocity trip is so sensitive that less than one gram of side pressure at the needle is required to operate it. At the same time, it is so balanced that it will not trip accidentally by slamming the drawer in which changer is mounted.

Let us consider the basic fundamentals of this velocity trip, examining the essential mechanical elements in progressive order. The first requirement is instant response between a driving member and a driven member.

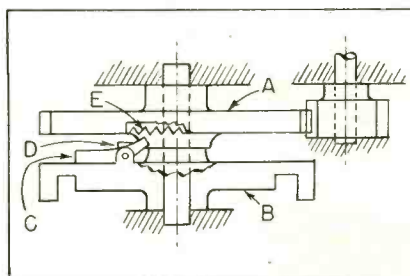

Figure 12

In Fig. 12, A is the driving member which rotates continually, receiving its power from the turntable. B is the driven member, or cam which, during one revolution performs all the motions required during change cycle, such as: raising the tone arm and swinging it out and in, and pushing the next record onto the turntable. C is the pawl which, being heavy on the back end, tilts up to engage teeth E in the top driving member, when released by stop D. In this manner, the cam receives instantaneous response to start the change cycle, as soon as stop D is released.

†Protected by patents.

\*LP is the trade-mark of Columbia Records.

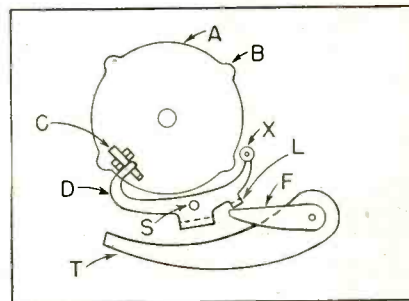

Figure 13

Let us next consider the release of stop D. The tone arm T in Fig. 13 is frictionally engaged to feather F which in turn pushes lug L on the stop member D which pivots around shaft S. When the tone arm advances slowly inward during record play, feather F pushes lug L. However, to prevent a continued motion of stop D, which would release pawl C prematurely, the bump B on driving member A pushes back the extremity of stop D, to "restore" the original positions of stop D and feather F. This "restoring" takes place at approximately each revolution of the turntable.

However, when the tone arm reaches the fast spiral grooves, there is sufficient motion of feather F, between the restoring bumps to unlatch the pawl C, and start the cycle.

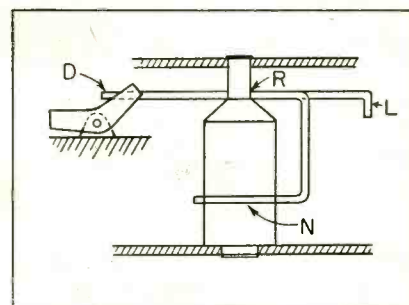

Figure 14

Now let us consider the forces required to trip this system, reflected in terms of side pressure on the needle. As pointed out previously, the vertical tone arm shaft friction is extremely light. There remains the friction of stop lever D, consisting of suspension on pivot shaft S, and drag of front end of pawl. In Fig. 14, showing a side view, it is noted that the stop lever is suspended on a reduced diameter shaft at R. Being made of light weight material, the shaft friction is at a minimum. There is no friction at the lower end

(Continued on page 109)



Beanstalk? . . . No! But like the proverbial Beanstalk

**RADIART SIMPLI-FLEX ANTENNA** *Sales*

**HAVE** *Shot Up* **OVERNIGHT**

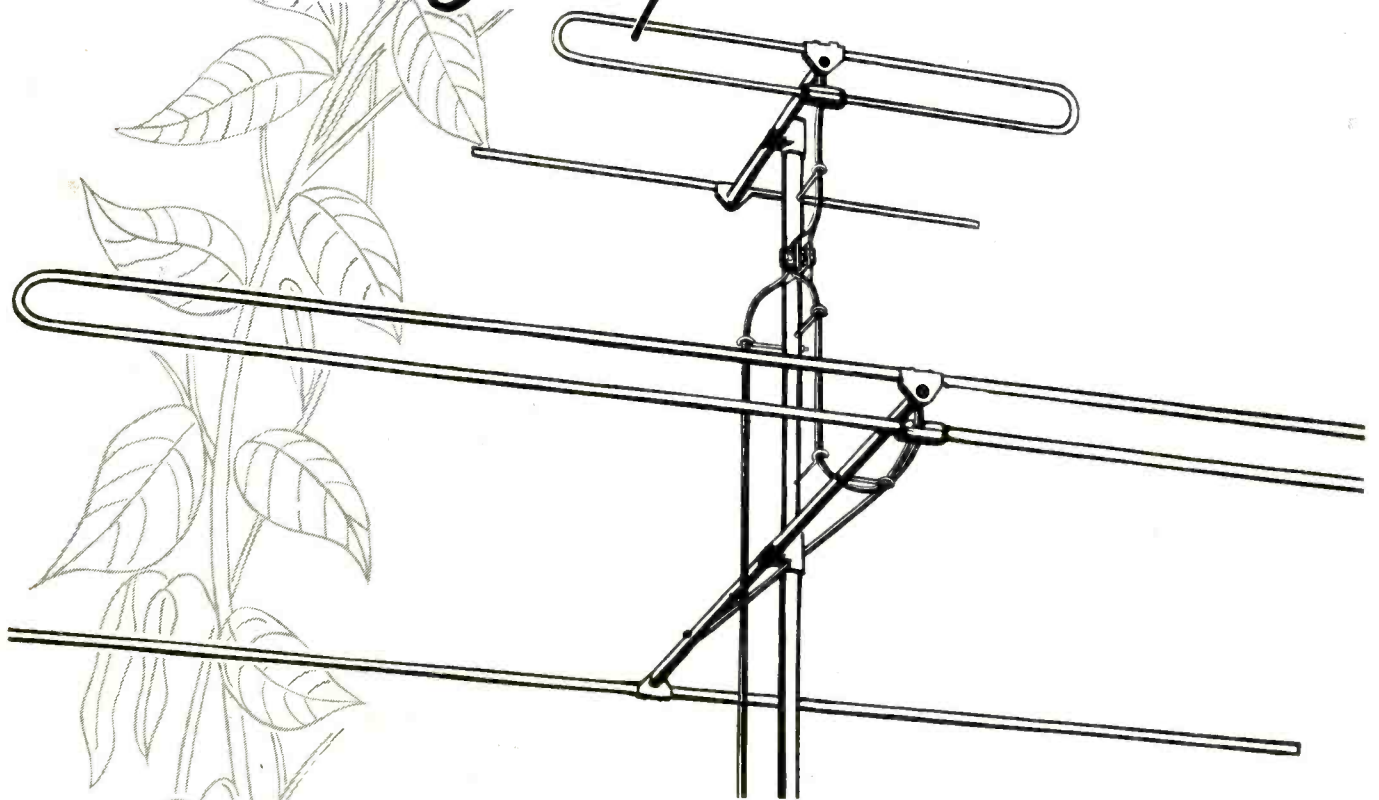

Wondering what all the excitement is all about? What is it that has shot up so quickly in demand? It's the RADIART line of SIMPLI-FLEX antennas! Practically overnight . . . like the proverbial beanstalk . . . these antennas have grown and sky-rocketed in popularity and taken the country by storm!

AND . . . the answer is simple enough . . . ELECTRICALLY . . . they out-perform all others—MECHANICALLY . . . they are easier to install, and more sturdy when installed!



IT'S RIGHT . . . WHEN IT'S RADIART

**THE RADIART CORPORATION**  
CLEVELAND 2, OHIO

Manufacturers of the Famous Red Seal Vibrators

# REACH NEW SALES HIGHS

## WITH THE PROFIT-PROVEN PENTRON LINE

### NEW "TWO-CHANNEL" TAPE RECORDER

Unmatched in tonal fidelity and quality, the new portable Pentron Tape Recorder has exclusive features unobtainable in any other recorder at this low price.

Studio type, does professional recording. Ideal for homes, schools, institutions and churches

Check these profitable features:

FULL HOUR'S RECORDING or playing . . . continuously  
FAST SPEED, both forward *and* reverse. No rethreading  
SYNCHRONIZED TIMING METER indexes all recordings  
AMPLIFIER High fidelity, 6 tube, 105 to 120 volts AC  
CAPSTAN DRIVE eliminates wow and flutter  
AUTOMATIC ERASING Can't accidentally erase while recording  
FULL FREQUENCY RANGE, 65 to 8000 cycles  
PUBLIC ADDRESS SYSTEM, high gain

### 4-IN-1 COMBINATION WIRE RECORDER

You have four prospects instead of one, and faster turnover, with this portable combination wire recorder, radio, phonograph and public address system! Engineered for high-fidelity response and trouble-free operation. The Pentron 4-IN-1 combination has the fastest rate of sales of any wire recorder on the market . . . definite proof of profit!

7-TUBE WIRE RECORDER records, plays back own radio, phono or mike for 1 full hour  
SUPERHETERODYNE RADIO, highly selective, built-in antenna  
TRU-TRACKING PHONO ARM, Astatic L70 Cartridge  
SYNCHRONIZED TIMING METER indexes all recordings  
TWO-WAY AUTOMATIC SHUT-OFF prevents wire tangle, breakage  
ONE TIME ERASURE absolutely guaranteed

### NEW COMPACT, FIDELITY WIRE RECORDER

No other wire recorder in this price range has the high fidelity, tonal beauty and features found in this precision built instrument. Engineered to give long trouble-free operation. An unbeatable profit item.

*All Pentron Recorders are fully covered by Product Liability Insurance.*

FULL HOUR'S RECORDING or playing . . . continuously  
SYNCHRONIZED TIMING METER indexes all recordings  
TWO-WAY AUTOMATIC SHUT-OFF prevents wire tangle, breakage  
PUBLIC ADDRESS SYSTEM, medium gain  
ONE TIME ERASURE absolutely guaranteed  
FREQUENCY RANGE, 75 to 7500 cycles, hum and flutter free

**FREE! TESTED DEALER MERCHANDISING AND SALES AIDS BUILD MORE TRAFFIC AND PROFITS FOR YOU!**

### PENTRON Astra-Sonic TAPE RECORDER



LIST  
**\$179.50\***  
COMPLETE  
Model No. T549

### RADIO-PHONOGRAPH PENTRON Astra-Sonic WIRE RECORDER PUBLIC ADDRESS SYSTEM



List  
**\$199.50\***  
COMPLETE  
Model No. W748

### PENTRON Astra-Sonic WIRE RECORDER



List  
**\$149.50\***  
COMPLETE  
Model No. W449

See us at the Radio  
Paris Show • Booth 34  
Rooms 535A, 536A  
Stevens Hotel

*A Few Distributorships still available, write to PENTRON*

*\* Slightly higher west of Rockies*

**THE PENTRON CORPORATION 611 W. DIVISION ST. CHICAGO 10, ILL., Export Agents—Scheel International, Inc.**

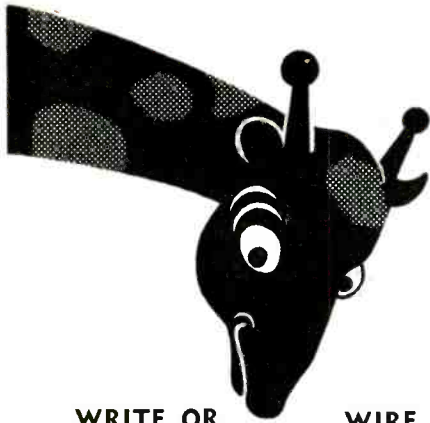

**WRITE OR  
YOUR NEAREST PENTRON  
DISTRIBUTOR NOW!**

#### CALIFORNIA

Fresno—Kierulf and Co.  
Inglewood—Acorn Radio Supply  
Long Beach—Fred S. Dean Co.  
Los Angeles—Figart's Radio Supply Co.  
Los Angeles—Kierulf and Co.  
Los Angeles—Radio Products Sales  
Oakland—Electric Supply Co.  
Oakland—E. C. Wenger Co.  
San Francisco—Pacific Wholesale Co.  
San Jose—Frank Quement Inc.

#### CONNECTICUT

Hartford—Hatry and Young Inc.

#### FLORIDA

Sarasota—Morley Radio Co.  
St. Petersburg—Cooper Radio Co.  
West Palm Beach—Goddard Distributors Inc.

#### ILLINOIS

Chicago—Allied Radio Corp. (Dealer Div.)  
Peoria—S & S Distributors

#### INDIANA

Evansville—Ohio Valley Sound Service  
Indianapolis—Kiefer-Stewart Co.  
Indianapolis—Van Sickle Radio Supply Co.  
Ft. Wayne—Wire Recorder Sales & Service

#### IOWA

Cedar Rapids—Webster Engineering Co.  
Davenport—Midwest-Timmermann and Co.  
Waterloo—Farnsworth Radio & Television

#### KANSAS

Wichita—Excel Distributors

#### MARYLAND

Baltimore—Wholesale Radio Part

#### MASSACHUSETTS

Boston—The Louis M. Herman Co.  
Newton—The L. Charlton Greene Co.

#### MICHIGAN

Detroit—The True Recorder Co.  
Kalamazoo—Electronic Equipment Co.  
Lansing—Capital Film Service  
Muskegon—Fitzpatrick Electric Supply Co.

#### MINNESOTA

Minneapolis—American Typewriter Co.

#### MISSOURI

St. Louis—Hollander and Co., Inc.  
St. Louis—Recordit Distributing Co.

#### NEW JERSEY

Newark—Aaron Lippman and Co.

#### NEW YORK

Buffalo—Dymac, Inc.  
New York—Malverne Distributors, Inc.

#### OHIO

Columbus—Whitehead Radio Co.  
Youngstown—Radio Parts Co.

#### OKLAHOMA

Oklahoma City—Radio Supply Inc.

#### PENNSYLVANIA

Johnstown—Cambria Equipment Co.  
Philadelphia—Radio Electric Service Co.  
Pittsburgh—Radio Parts Co.

#### SOUTH CAROLINA

Spartanburg—McElhenney Radio Supply House

#### TENNESSEE

Nashville—Radio and Appliance Corp.

#### TEXAS

Austin—Standard Radio Supply Inc.  
Corpus Christi—Wicks-De Vilbiss Co.  
Dallas—Crabtree's Wholesale Radio  
Dallas—Southwest Radio Supply  
Fort Worth—Clifford-Herring Sound Eqpt. Co.  
Houston—Sterling Radio Products Co.  
San Antonio—South Texas Radio Supply Inc.

#### WASHINGTON

Seattle—Radio, Television & Appliance Inc.  
Spokane—Inland Sales Inc.

#### WISCONSIN

Milwaukee—Continental Engineering Co.  
Washington, D.C.—Electronic Wholesalers, Inc.

**RECORDERS OF PROVEN MERIT**

## Names in the News

Waring Products Corporation, through J. P. McIlhenny, vice-president in charge of sales, announces the appointment of its own salesforce in metropolitan and upstate New York and northern New Jersey. Waring Blenders and Waring steam irons will be handled by D. F. Natter in upstate New York and by C. M. Lyng, Jr. and B. F. Innes in the metropolitan area and New Jersey.

Creation of a marketing division to consolidate all sales, advertising and promotional activities of the Coleman Co., Inc., has been announced by Sheldon Coleman, executive vice-president and general manager. The division will be headed by R. W. Carney.

Announcement has been made by John M. Olin, president of Olin Industries, Inc., East Alton, Ill., of the appointment of W. C. Schade as manager of product divisions for the company. The announcement marks a further advance in the development of a product management form of organization for the company.

Robert R. Foster has been appointed a General Electric appliance sales representative in the Nashville office of the Company's southeastern district, according to J. M. Walker, district manager of appliance sales.

Carl R. Busch has been appointed district sales engineer for the Westinghouse Lamp Division's eastern district. The announcement was made by F. S. Kinsey, manager.

Rodney M. Pollard has been appointed a General Electric appliance sales representative in the Seattle office of the Company's Pacific district, according to B. M. Tassie, district manager of appliance sales. Mr. Pollard, who will represent GE heating devices and fans, attended the University of Texas, and was formerly with the General Electric Credit Corporation in San Francisco.

C. W. Mills has been appointed sales promotion manager for the Northwestern district of the Westinghouse Electric Corporation, with offices in Chicago. He succeeds C. A. Emery, who has resigned to enter another line of business. The announcement was made by J. M. McKibbin, assistant to the vice-president in charge of advertising and sales promotion for the company.

A. C. Sayland has been appointed chief engineer of the Motorola consulting service, with headquarters in Washington, D. C., according to an announcement by Motorola, Inc., Chicago, manufacturers of radio and television equipment.

R. J. White, a member of the Philco sales organization for 19 years, has been appointed manager of distribution of the Electromaster Division of the Corporation in accordance with Philco's plans to sell electric ranges under the Electromaster name, it is announced by John M. Otter, vice-president and general sales manager of Philco.

Cory Corporation of Chicago, manufacturers of Corey coffee brewing equipment and home appliances and Fresh'nd-

Aire electric fans, air circulators and humidifiers, has named E. J. Alexander, sales manager, commercial products.

Appointment of three new regional sales managers, who will serve with two managers already holding similar positions to head up the Philco sales organization in the major geographical areas of the country, is announced by John M. Otter, vice-president and general manager of sales, Philco Corporation. Stuart A. Falk, east-central sales manager with headquarters in Cleveland, will handle the company's Allegheny and Eastern sales divisions. C. E. Lindstrom, new eastern sales manager with offices in New York City, will be responsible for Philco sales in the Atlantic, Capital and New England divisions. John E. Ramsey, southern sales manager in Atlanta, will supervise the company's Delta, Southern and Texas sales divisions.

Four new Maytag regional managers have been assigned to sales territories east of the Mississippi. The new regional sales managers are Ted L. Rogers, with supervision of seven counties in and around Dayton, Ohio; E. F. (Jack) Glascoe, with twenty-nine counties in northwest North Carolina; George Playford, who is supervising seven counties in central New Jersey; and Vernon A. Bird, who takes over twelve counties in north central New York State.

The appointment of L. S. Thees as general sales manager of the RCA Tube Department has been announced by L. W. Teegarden, vice-president in charge of technical products, RCA Victor Division, Radio Corporation of America.

Herbert Stumpf has been appointed Coolerator district manager for Buffalo, New York, it is announced by William C. Conley, Jr., sales manager for The Coolerator Company of Duluth, Minn.

Robert Hayter has been named sales manager for the Lyte Parts Company of Plainfield, New Jersey. The Lyte Company, manufactures TV-AM-FM antennas in plants in Plainfield and Du-buque, Ia.

A. F. (Pete) Hellert has been named eastern division manager for National Union equipment manufacturer tube sales according to G. A. Bodem, vice-president in charge of sales.

Following six months in the television and microwave engineering department of Raytheon Manufacturing Company, Waltham, Mass., William E. Neill has been appointed sales engineer of the department.

D. H. Cogan, president of Air King Products Company, Inc., announces the appointment of the Joseph Katz Company to handle all advertising and promotion for Air King Television sets, radio receivers and wire recorders.

Jack Edwards, who has managed General Mills' Home Appliances in the Midwestern district with offices in St. Louis, has been named manager of the central district with offices in Chicago. J. D. Peoples was named to head the St. Louis office. The changes were announced by R. P. Kelley, sales manager for home appliances.

# TV ANTENNAS, ACCESSORIES

## Towers TV-FM MAST

This is a tubular, alloy-steel mast with a universal mount to which any type of antenna can be mounted. Mast is five feet long and can be built to any height with Towers five-foot, telescoping extensions. Each mast is furnished with guy-wire ring, eleven-inch base, and antenna mounting block. Mast and extensions are furnished in either 1" or 1¼" diameters. Towers Corp., 3332 E. 55th St., Cleveland 4, Ohio.—RADIO & TELEVISION RETAILING.

## Vee-D-X CHIMNEY MOUNT

The chimney and vent pipe antenna mount fits inside the chimney or vent pipe. Maker claims the mount fits into any opening from 4 to 22 inches regardless of shape, and accommodates masts of 1, 1½ and 1¼ inch diameter. Unit lists for \$7.50. La Pointe-Plascomold Corp., Unionville, Conn.—RADIO & TELEVISION RETAILING.

## G-C TV ANTENNA BRACKETS

Model 8000 is a universal hinged mast bracket which permits antenna to be assembled in downward position and then swung up. 8001 Chimney mount utilizes brackets which can be spread to any width desired. These brackets can also be mounted on gables, corners, or flat surfaces. Both types will hold masts up to 1½ inches in diameter, and list price on either is \$7.50. General Cement Mfg. Co., 919 Taylor Ave., Rockford, Ill.—RADIO & TELEVISION RETAILING.

## Metalace ANTENNA MOUNT

Model CMA is a two-piece chimney type antenna mount designed to allow any space between mast brackets. Unit is pre-assembled, with a turnbuckle and 12 feet of strapping provided with each of the two mounts. Masts ¾ to 2½ inches can be accommodated. List is \$4.75 per set. Metalace Corp., 2101 Grand Concourse, New York 53, N. Y.—RADIO & TELEVISION RETAILING.

## Insuline INDOOR TV ANTENNA

The "Wasp" is a new antenna with a swivel base into which two adjustable, telescoping dipoles are set. It features vertical and horizontal orienting. It stands

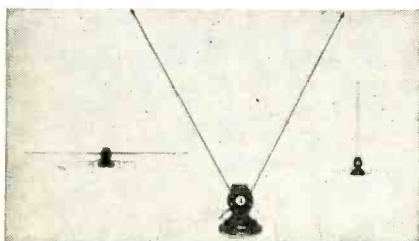

19" high closed; base measures 3¾" in diameter. Price with 8 feet of 300 ohm lead is \$6.95 retail. Insuline Corp. of America, 3602 35th Ave., Long Island City 1, N. Y.—RADIO & TELEVISION RETAILING.

## JFD INDOOR TV ANTENNA

"Tele-Vee" is equipped with adjustable telescopic brass dipoles, and features a marblite base which is said to be tip-

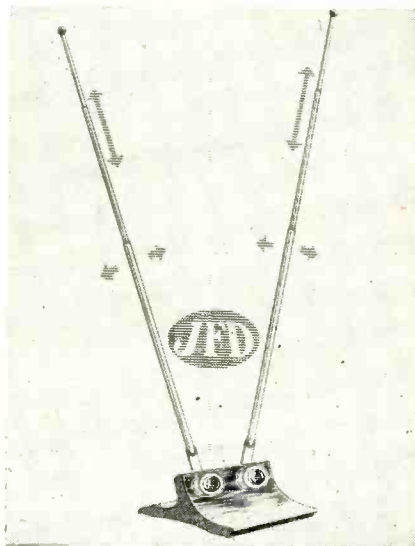

proof. Weighing under 1½ pounds, Tele-Vee is supplied with 10 feet of 300 ohm line. JFD Manufacturing Co., Inc., 4117 Ft. Hamilton Pkwy., Brooklyn 19, N. Y.—RADIO & TELEVISION RETAILING.

## Tricraft INDOOR TV ANTENNA

Model 600 is designed for indoor TV operation and in appearance resembles a small cylinder or tube on a stand. Antenna elements are concealed, and a switch is provided on the outside to tune in different channels. Weight is 3¾ pounds. Tricraft Products Co., 1535 N. Ashland Ave., Chicago, Illinois.—RADIO & TELEVISION RETAILING.

## Visibeam INDOOR TV ANTENNA

Model C "Panel" Visibeam antenna is an indoor type designed to appear like a tan leatherette panel, for better concealment or harmony with interior furnishings. Maker claims broad band response over both TV bands, with sharply directional characteristics. Retail price is \$17.50. Burnett Service Co., 178 W. 168th St., New York 52, N. Y.—RADIO & TELEVISION RETAILING.

## Delson TV WINDOW ANTENNA

Jiffy-Tenna can be installed in a window, closet or similar space without tools. Telescoping trombone ends on the folded dipole can be adjusted for maximum response. When these ends are removed, the Jiffy-Tenna becomes a straight dipole with reflector. List price is \$16.75. Delson Mfg. Co., 126 11th Ave., New York 11, N. Y.—RADIO & TELEVISION RETAILING.

## Anchor INDOOR TV ANTENNA

The Super-Tenna is an adjustable folded dipole antenna mounted on a base suitable for standing on a table or floor, and is designed for indoor TV reception. Maker claims impedance match to 300 ohms on all channels. List price is \$8.95. Anchor Radio Corp., 2215 S. St. Louis Ave., Chicago 23, Illinois.—RADIO & TELEVISION RETAILING.

## Snyder PORTABLE TV ANTENNA

Model PTV, Tele-Port aerial consists of telescopic straight dipoles on an iron base and is designed to be placed on the television set or anywhere in the room. Orientation is provided by rotating the antenna on its base. Snyder Mfg. Co., 22nd and Ontario Sts., Phila. 40, Pa.—RADIO & TELEVISION RETAILING.

## Flextron INDOOR TV ANTENNA

Of novel design, this new indoor antenna features small size and easy orientation for TV reception without a roof antenna. Fifteen inches high, the indoor antenna has

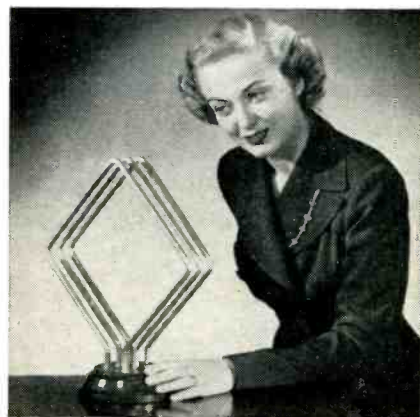

aluminum rods with a brown base. List price is \$9.95. Electro-Steel Products, Inc., 112-114 N. Seventh St., Phila., 6, Pa.—RADIO & TELEVISION RETAILING.

## Gyro INDOOR TV ANTENNA

Gyro-Tenna type V-1 consists of two extendable dipole elements mounted on a plastic base. Each element may be raised or lowered and the entire antenna may be rotated. V-1 is designed to cover all TV and FM channels. List price is \$5.95. Public Operating Corp., 100 W. 42nd St., New York, N. Y.—RADIO & TELEVISION RETAILING.

## Jerrold INDOOR TV ANTENNA

The Jerrold In-tenna combines an adjustable dipole with a TV preamplifier, combining boost, tuning, and orientation in one unit. The In-tenna was designed for apartment installations where an outdoor antenna cannot be erected. Retail price is \$42.50. Jerrold Electronics Corp., 121 N. Broad St., Philadelphia, Penna.—RADIO & TELEVISION RETAILING.

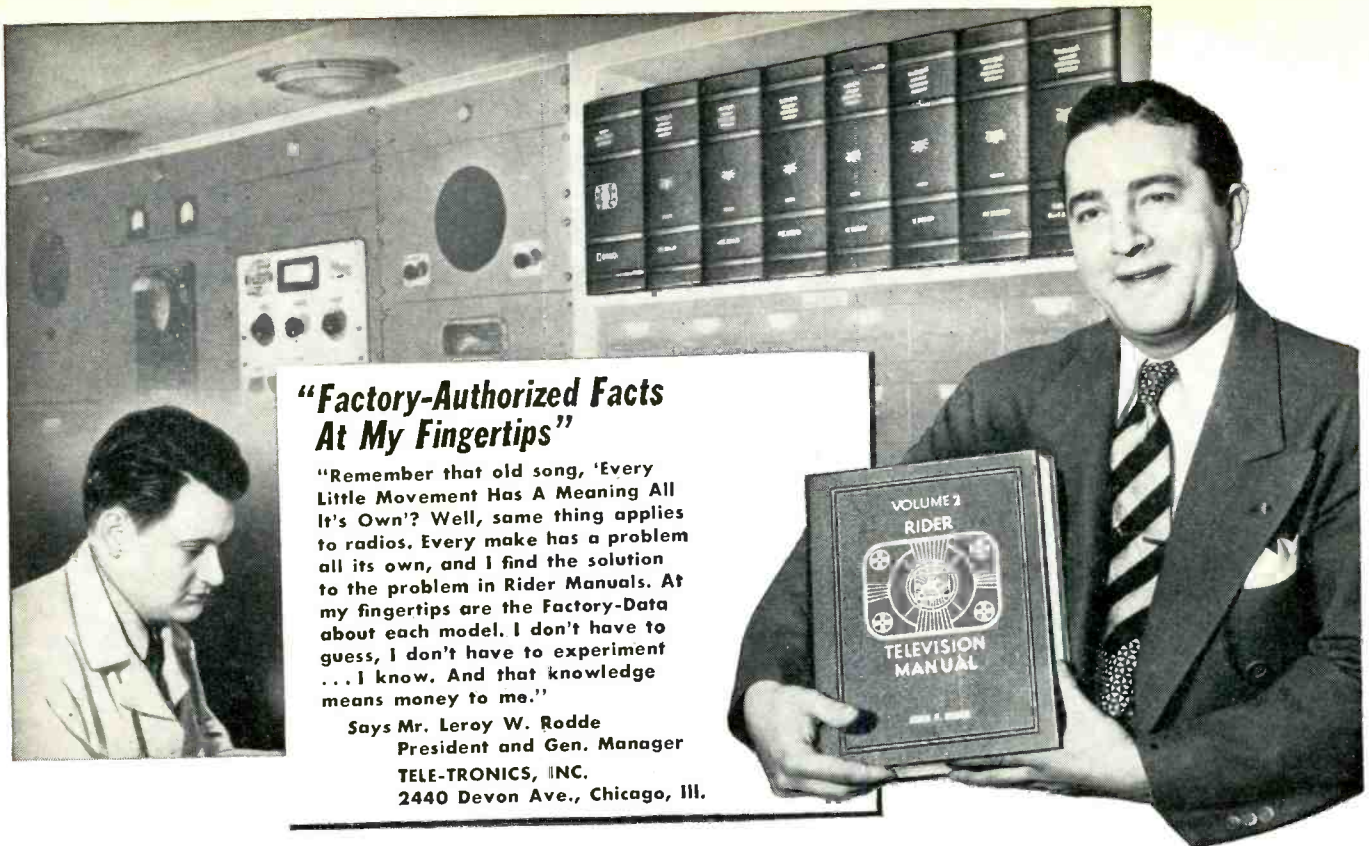

**"Factory-Authorized Facts At My Fingertips"**

"Remember that old song, 'Every Little Movement Has A Meaning All It's Own'? Well, same thing applies to radios. Every make has a problem all its own, and I find the solution to the problem in Rider Manuals. At my fingertips are the Factory-Data about each model. I don't have to guess, I don't have to experiment ... I know. And that knowledge means money to me."

Says Mr. Leroy W. Rodde  
President and Gen. Manager  
TELE-TRONICS, INC.  
2440 Devon Ave., Chicago, Ill.

**Only RIDER MANUALS**  
Supply ALL the AUTHENTIC, OFFICIAL, RELIABLE Servicing Data  
Direct From the Manufacturers... AM-FM-TV — and Allied Equipment

**Available Now! VOLUME 18**  
2036 Pages PLUS "How It Works" Book and Cumulative VOLUMES XVI, XVII, XVIII Index. Both Books, Complete..... \$19.00

Authentic factory-data covering models and chassis of AM and FM receivers and record changers of more than 100 manufacturers, up to date to January, 1949. Exclusive RIDER "Clari-Skematix" give break-downs of hard-to-trace multi-band receivers, showing circuit wiring of each band.

**Now Available! RIDER TELEVISION MANUAL-VOLUME 2**  
2000 Pages PLUS Cumulative Index Covering TV Volumes 1 and 2 ..... \$18.00

AUTHENTIC, OFFICIAL Service Data on Complete Receivers and Kits and Boosters direct from the service departments of 57 TV manufacturers. Double, triple spreads and giant pages that unfold to 4440 square inches. Test patterns, wave forms, schematics, voltages, adjustment of traps, complete alignment tables. Parts list.

For 18 years, RIDER MANUALS have been the ONE and ONLY dependable source of data to help servicemen solve any problem on any make or model of radio in existence. That's because RIDER MANUALS incorporate ALL, and we did say ALL, the AUTHENTIC, OFFICIAL data as put out by the manufacturers themselves. For example, in TV MANUAL VOLUME 2, we show seven different chassis for the same model number. Only RIDER MANUALS offer you such scope, such a wealth of information, and in such easily-followed form.

**RIDER MANUALS**

Vol. XVIII .....	2032 Pages \$19.80	Vol. XI .....	1652 Pages \$16.50
Vol. XVII .....	1648 Pages \$16.50	Vol. X .....	1664 Pages \$16.50
Vol. XVI .....	768 Pages \$ 8.40	Vol. IX .....	1672 Pages \$16.50
Vol. XV .....	2000 Pages \$19.80	Vol. VIII .....	1650 Pages \$16.50
Vol. XIV .....	1376 Pages \$16.50	Vol. VII .....	1600 Pages \$16.50
Vol. XIII .....	1672 Pages \$16.50	Vol. VI .....	1240 Pages \$12.50
Vol. XII .....	1648 Pages \$16.50	Abridged Manual	
Rider Television Manual, Vol. 1 (Incl. HOW IT WORKS and INDEX).....	2000 Pages \$19.80	Vol. I-V .....	\$18.00
Rider Television Manual, Vol. 2 (Incl. HOW IT WORKS and INDEX).....	\$18.00		

**RIDER PA MANUAL**

The first industry-wide public address equipment Manual, covering amplifier production of 147 manufacturers from 1938 to 1948. 2024 Pages PLUS "How It Works" Book. \$18.00 Complete

**Your Jobber Carries a Full Line of RIDER MANUALS**  
**RIDER MANUALS mean SUCCESSFUL SERVICING**

**JOHN F. RIDER, PUBLISHER, Inc., 480 Canal St., New York 13, N. Y.**

Export Agent: Rocke International Corp., 13 East 40th Street, N. Y. C., Cables, ARLAB

**IMPORTANT NOTE!** Are you receiving your copy of "Successful Servicing"? It's Rider's own publication of interest to every Serviceman. Send your name and address, and we'll put you on our list, FREE of charge.

NOTE: The Mallory Radio Service Encyclopedia, 6th edition, makes reference to only one source of radio receiver schematics—Rider Manuals.  
ANOTHER NOTE: The C-D Capacitor Manual for Radio Servicing, 1948 edition No. 4, makes reference to only one source of receiver schematics—Rider Manuals.

# NEW SERVICE AIDS

## RCA DIODE PROBE

The twin-diode probe (WG-275) is now available for use with the Master Volt-Ohmyst (WV-95A) to make that instrument

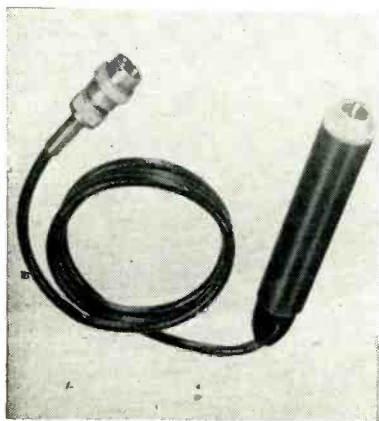

useful for high frequency measurements. The probe has a flat response from 30 cps to 250 mc., reading sine wave voltages in RMS values. RCA Tube Dept., Harrison, N. J.—RADIO & TELEVISION RETAILING.

## Ideal SOLDERING TOOL

Thermo-Grip soldering tools operate on a resistance heating principle in which touching the work with the tool completes the power circuit and causes the part touched to heat almost instantly. Attachments for handling work include a "pliers" for holding lugs, terminals and the like, and a "pencil" attachment for spot soldering. The line includes 80, 450, 1000, and 2500 watt tools. Ideal Industries, Sycamore, Illinois.—RADIO & TELEVISION RETAILING.

## Hexacon SOLDERING IRON

Designed for heavy duty work, this iron is powered at 700 watts, with a replaceable 1 3/4 inch diameter screw type tip. Operates on any cycle, AC or DC current, furnished for either 110 or 220 volts. List on model 700 is \$27.00. Hexacon Electric Co., 195 W. Clay Ave., Roselle Park, N. J.—RADIO & TELEVISION RETAILING.

## Multicore ERSIN FLUX

Ersin flux is a white resin flux for which the maker claims high resistance to corrosion as well as increased speed of soldering. In liquid form, Ersin flux comes in 1 gallon containers, packaged 6 to a carton at \$4.00 gallon, and in 5 gallon drums at \$3.50 gallon. For further details, write to British Industries Corp., 315 Broadway, New York, N. Y.—RADIO & TELEVISION RETAILING.

## Electro-Voice MIKE STAND

Model 426 microphone desk stand features a newly developed shock mount to prevent reproduction of external shocks and vibration. Adapter is provided to fit all 5/8-27 thread microphones. List is \$20.00. Electro-Voice, Inc., Buchanan, Mich.—RADIO & TELEVISION RETAILING.

## Super-Tool MASONRY DRILLS

A complete line of spiral-fluted, carbide-tipped masonry drills is available in sizes from 1/8 to 1 1/2 inches in diameter, and up to 20 inches in length. Adaptable for all

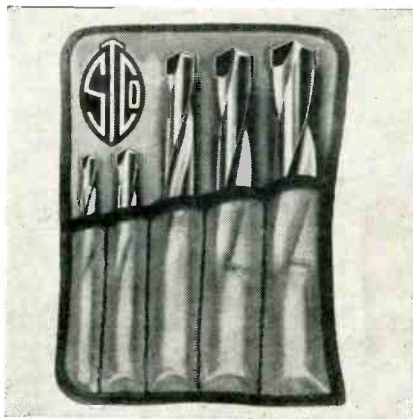

types of work which involve drilling holes in brick, stone, marble, tile or slate, these drills will be useful for the installation of TV antennas on chimneys, walls, etc. Super Tool Co., 21650 Hoover Road, Detroit 13, Mich.—RADIO & TELEVISION RETAILING.

## Hamer-Dril DRILL ADAPTER

For drilling in tile, brick, cement and stone, Hamer-Dril converts any 1/4-inch chuck electric drill to a power hammer.



A combination of percussion and rotation is provided to facilitate masonry drilling. Hamer-Dril, Box 158, Planetarium Station, New York 24, N. Y.—RADIO & TELEVISION RETAILING.

## Mueller TV STANDOFF

Tenna-Clampipe is a standoff insulator for TV and FM downleads that clamps onto the antenna mast or similar support. It is an assembly consisting of a ground clamp and a screw-eye with a plastic, insulating grommet. There are two types, one for twin-lead and one for coax type round cable. Usable on any rigid object up to 1 3/8 inches in diameter or thickness, Tenna Clampipe can be clamped on cellar pipes, I-beams, etc., as well as masts. Mueller Electric Co., 1583 East 31st St., Cleveland 14, Ohio.—RADIO & TELEVISION RETAILING.

## Sylvania MULTIPLIER PROBE

When used in place of the standard Polymeter low-voltage probe, the new DC voltage multiplier extends measurements to 10,000 volts by multiplying each of the present DC voltage ranges by 10. Unit is provided with 48-inch plug-in flexible lead. Sylvania Electric Products, Inc., 500 Fifth Ave., New York 18, N. Y.—RADIO & TELEVISION RETAILING.

## Roto-Power POW'R-HAM'R

Pow'r ham'r is an adaptor tool which converts an electric drill into a hammer for drilling into cement, stone, brick, tile, etc. It is provided with two holders to fit 10 sizes of Rawlplug drill bits, Anchor drill bits, and others from No. 6 woodscrews to 5/8". Price is \$9.50 net. Roto-Power Corp., 283 Greene Ave., Brooklyn 5, N. Y.—RADIO & TELEVISION RETAILING.

## Duo-Fast TWINEX STAPLER

This automatic gun tacker for tacking down 300-ohm TV transmission line is equipped with a special guide to make certain the staple is driven exactly in the

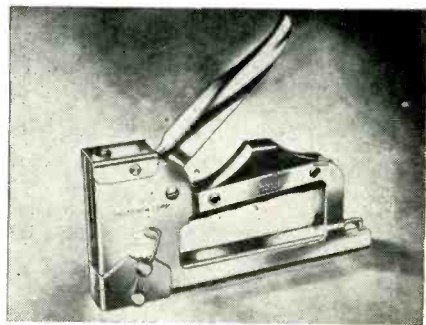

center of the cable. By removing the special guide, the tacker can be used for other jobs. Fastener Corp., 860-902 Fletcher St., Chicago 14, Ill.—RADIO & TELEVISION RETAILING.

## Heller UNIVERSAL SCREW STARTER

The screw-starter is designed to grip the screw head as you start the screw in close places beyond the reach of hand or instrument. Effective on slotted, Phillips, and all special screw heads. Universal screw starters are made in 3 lengths: 5", 8", 11", medium and light dual bits, insulated and plain shafts. George P. Heller Co., 2019 Grand Ave., Kansas City 8, Missouri.—RADIO & TELEVISION RETAILING.

## Custom Craft TEST-AID

This test instrument permits substitution of 11 different resistance values and 11 different capacitance values in the receiver under test while in operation. In addition, provision is made for condenser leakage tests, continuity checks, and approximate measurement of resistance and capacitance values. List price is \$15.95. Custom Craft Mfg. Co., 256 E. 98th St., Brooklyn 12, N. Y.—RADIO & TELEVISION RETAILING.

Here's what  
radio men  
say about

# SYLVANIA'S DEALER CAMPAIGNS



TRY OUR RADIO TROUBLE SHOOTERS PHONES AROUND DEPENDABLE

**MIKE'S**  
RADIO AND TELEVISION SERVICE  
EXPERT SERVICE ON ALL MAKERS  
10802 1/2 WEST PICO  
LOS ANGELES, CAL.

November 1, 1948

Advertising Department  
Sylvania Electric Products Inc.  
Emporium, Pa.

Gentlemen:

I would like this opportunity to tell you how much the Sylvania co-ordinated advertising campaign has helped my business.

Although I have used direct mail postal cards in the past for soliciting new business, the tie-in with national advertising offered in the Sylvania campaign was responsible for an extraordinary return. The response I have had from your campaign has been truly amazing.

As an example, I mailed 1000 postal cards in May at a cost to me of \$10.00. To date this investment has brought a return of \$352.19. During June, July and August I mailed another 1000 cards each month at a total cost of \$30.00. To date the return from this investment has amounted to \$760.46.

You will note that for a total investment of \$40.00 I have, to date, enjoyed an increase in business amounting to \$1,112.65 -- all from new customers. I can safely say that there is still more business to come from these cards in future months.

I mailed another 1000 cards to my prospect list of 12,964 names during October and November. I also expect to mail another 1000 cards during December.

Speaking for myself, I would certainly like to see this campaign become a regular 'shot in the arm' at least twice a year. It will do much to help business in the spring and early fall when business is usually slow.

Many thanks and best wishes.

Very truly yours  
MIKE'S RADIO SERVICE

By *Michael Waxman*  
Michael Waxman



BEING IN YOUR RADIO TUBES - WE TEST THEM FREE - DEALERS FOR SYLVANIA SEE TESTED TUBES

## SCURLOCK'S RADIO SHOP

ELECTRICAL APPLIANCES -- HARDWARE  
EVERYTHING PERTAINING TO RADIO  
SUMITON, ALABAMA

September 18, 1948

Advertising Department  
Sylvania Electric Products Inc.  
Emporium, Pa.

Gentlemen:

In 1937 when we started our radio repair business, we used personal postal cards to get our name before our prospective customers. For a beginner, this kind of advertising seemed a little more than we could pay, although it did wonders for our business.

We are happy that the service industry has a great company behind us with national advertising and personal postal cards. During your first co-ordinated advertising campaign we bought 1200 cards and mailed them to our customers according to Sylvania's specifications. The results were so effective that we are going to use the campaign again. We want to see if the campaign is really responsible for the extra business we are enjoying.

The "funny cards", as our customers call them, are even responsible for payment of some of our past due accounts. Our radio sales are up. We are making allowance for old radios which our customers get out for us to repair after receiving our atomic reminder card.

We want to personally thank Sylvania for taking an interest in us and giving us this low cost, yet effective, advertising.

VERY KINDLY YOURS

*J. B. Scurlock*  
J. B. SCURLOCK

## Like these service dealers you can increase your business

Sylvania's May, June, July and August campaigns are ready for you. Here's what you receive:

- 4 Postal Card Mailings—one for each month.
- 4 Window Displays—one for each month.
- 4 Window Streamers—one for each month.
- 8 Newspaper Ad Mats—two for each month.
- Radio Spot Announcements—several for each month.

Send for full details now! Remember, you pay only the postage on the government postal cards you mail. Sylvania supplies everything else free!

# SYLVANIA ELECTRIC

RADIO TUBES; CATHODE RAY TUBES; ELECTRONIC DEVICES; FLUORESCENT LAMPS, FIXTURES, WIRING DEVICES; PHOTOLAMPS; LIGHT BULBS

Sylvania Electric Products Inc.  
Advertising Department, R-2104  
Emporium, Pa.

Gentlemen: Send full information on your May, June, July and August Service Dealer Campaigns.

Name \_\_\_\_\_  
Company \_\_\_\_\_  
Address \_\_\_\_\_  
City \_\_\_\_\_ Zone \_\_\_\_\_  
State \_\_\_\_\_

# TACOVISION

that certain something **EXTRA!**

**Type 925 Hi-Lo Band Antenna.**  
Covers 13 TV channels. Independent orientation for each section. Features JIFFY-RIG set up. All - aluminum construction.

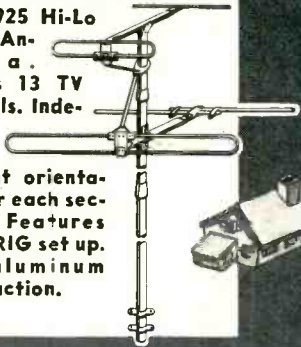

**Type 960 Super High - Gain Low Frequency Antenna.**  
Covers channels 2-6. Peaked at any low - channel. JIFFY-RIG assembly saves erection time. 15' Aluminum mast.

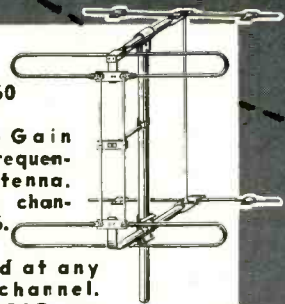

**Type 510 High-Low Band Antenna.**  
Single lobe characteristics. Features JIFFY-RIG assembly. Stacking adapters available. Aluminum mast.

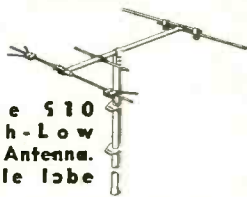

strong signal areas  
weak signal areas



Years of antenna engineering and craftsmanship are reflected in TACO products. That's the "something extra" — the superlative TV results — the best in television pictures — TACOVISION, for short.

Ask our jobber to show you the TACO kit that best fits your needs. Catalog on request.

**Type 444 Extra-High-Gain High-Frequency Adapter.**  
Channels 7-13. Used alone in high-frequency areas. Attaches mechanically and electrically to any 300-ohm antenna.

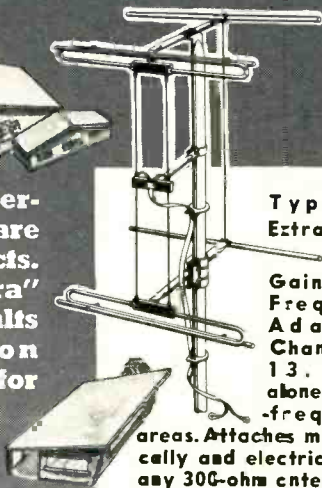

## Televisa TABLE MODEL

3-gang, super-heterodyne, full size table model radio which will retail at \$29.63. Televisa "Sky Ranger" is built to a sensitivity of better than 15 micro-volts on antenna. This makes the "Sky Ranger" ideal for city areas where reception is generally noisy and particularly fine for that 50% of the nation (rural areas) in lower signal strength regions. The "Sky Ranger" is a super-heterodyne 6-tube set, including rectifier. Televisa Corporation of America, 114 East 16 St., New York City 3.—RADIO & TELEVISION RETAILING.

## Emerson TELEVISION SET

Model 618 is the first 12-inch tube TV set made by Emerson, giving a picture approximately 75 square inches in area. The set is a console with FM-AM radio and phonograph and retails at \$529.50. Emerson Radio and Phonograph Corp., 111 8th Ave., New York, N. Y.—RADIO & TELEVISION RETAILING.

## Auditorium PROJECTION TV SET

A 20 by 26 inch picture is provided on this projection TV receiver, housed in a cabinet suitable for commercial installations. Set features a Dumont Imputuner, Bausch and Lomb projection lens and Eastman Kodak viewing screen, and is similar to the Television Assembly Co., P-520, made by a subsidiary company. Snader Television Corp., 540 Bushwick Ave., Brooklyn, N. Y.—RADIO & TELEVISION RETAILING.

## RCA PICTURE MAGNIFIER

Type 205PI television picture magnifier designed for smaller television receivers enlarges the images on sets with 7-inch tubes to approximate equivalent in size of those received on 12-inch tube. Oil-filled plastic lens is \$24.95, complete with mounting brackets. Masked picture space measures 8 x 11 inches. RCA Tube Department, Harrison, N. J.—RADIO & TELEVISION RETAILING.

## UST TV-RADIO CONSOLETTTE

New model to list at \$625. features a 15-inch television set plus FM radio. The floor-model type cabinet eliminates the



necessity for a table. The picture tube is a flat-faced type which permits large viewing area. United States Television Corp., 3 West 61 Street, New York 23, N. Y.—RADIO & TELEVISION RETAILING.

# TACO

RADIO & ELECTRONIC EQUIPMENT  
TECHNICAL APPLIANCE CORP.  
SHERBURNE, N. Y.

IN CANADA: STROMBERG-CARLSON CO., LTD., TORONTO 4, ONT.



**ANNOUNCING...**  
**"Three-Sixty" Hypex**  
**PROJECTORS**



**MODEL VR-11 "THREE-SIXTY" HYPEX**  
 (above) 15 WATTS; 280 CPS CUT-OFF.  
**MODEL VR-241 "THREE-SIXTY" HYPEX**  
 (at right) 25 WATTS; 140 CPS CUT-OFF.

**T**WO new Hypex\* Projectors—designed for 360-degree sound dispersal—are now available. With sound distributed horizontally in all directions, these new models are intended for installations where coverage of relatively large areas and suspension from the ceiling are desired. Like all Hypex Projectors, these radial units incorporate the famous Hypex formula† which results in improved acoustic performance.

By the addition of the two radials to the four previously announced Hypex units illustrated below, the Hypex line now includes a model for every "sound" need, indoors or outdoors.

**Jensen**  
**Hypex**

**JENSEN MANUFACTURING COMPANY**

Division of the Muter Company

6633 SOUTH LARAMIE AVENUE, CHICAGO 38, ILLINOIS

\*Trade Mark Registered †Patent 2,338,262

Write for Data Sheet 143

In Canada: COPPER WIRE PRODUCTS, LTD., 351 CARLAW AVENUE, TORONTO



**MODEL VH-24 HYPEX**  
 25 WATTS; 110 CPS CUT-OFF

**MODEL VH-20 HYPEX**  
 25 WATTS; 140 CPS CUT-OFF

**MODEL VH-15 HYPEX**  
 15 WATTS; 180 CPS CUT-OFF

**MODEL VH-91 HYPEX**  
 15 WATTS; 300 CPS CUT-OFF

# LOSE NO TIME

- 1 MAKE THE SALE!
- 2 MAKE THE INSTALLATION!
- 3 MAKE THE PROFIT!



With only 3 basic models in the HANDY TORQUE-DRIVE SALES and SERVICE KIT, you can immediately replace any one of over 150 standard type pickup cartridges in common use. There's no special trip to make to your supplier for a cartridge . . . there's no lost time, no lost sale! You make a quick profit . . . you make your customer happy . . . and you actually give him a superior cartridge! Ask your E-V Distributor or send for Bulletins 141-142. (New Model L14 Microgroove Crystal Cartridge also available)

E-V Pat. Pend. Licensed under Brush Patents

**ELECTRO-VOICE, INC.**  
BUCHANAN, MICHIGAN

Export: 13 E. 40th St.,  
New York 16, U.S.A.  
Cables: Arlab

IT PAYS TO REPLACE WITH

**Electro-Voice**

**Robert M. Oliver**



Mr. Oliver's appointment to the newly created position of general merchandise manager of the Traffic Appliance Division of Landers, Fray & Clark was announced by Bret C. Neece, vice-president of the company. Mr. Oliver formerly was vice-president in charge of sales of the Proctor Electric Company.

### Hytron Issues Guide

Hytron Radio & Electronics Corp., Salem, Mass., announces that the third edition of the Hytron Reference Guide for Miniature Electron Tubes is available at Hytron jobbers, or directly from the company, free of charge. This latest edition contains 91 types, 19 of them new; contains pertinent characteristics, data and basing diagrams for all miniatures announced to date, regardless of make.

### Service Sections Moved

The Coolerator Co., Duluth, Minn., has announced the transfer of its service departments from the factory to new quarters at 526 South Lake Ave. National service department general offices as well as parts and repair divisions will be moved to the new location.

### Hotpoint Dishwasher



Attractive Mrs. Helen Olson tries out the new automatic electric Hotpoint dishwasher that was awarded on a radio program for the Chicago Heart Association.

# New Service Components

## Perfection LOUDSPEAKER

This 2-inch PM speaker is said to have low frequency response down to 240 cycles, affording more tonal balance than is usually available with such a small cone. Different magnet weights and pot structures are available to suit special situations. Perfection Electric Co., 829 South State St., Chicago 5, Ill.—RADIO & TELEVISION RETAILING.

## Permoflux REPLACEMENT SPEAKERS

Four new models have been added to the Permoflux line of replacement speakers for TV sets. These new models are 4 x 6, 5" and 6", with 62 ohm field and 4 ohm voice coil and a 4 x 6 with 100 ohm field and 4 ohm voice coil. The addition of these new models means that Permoflux now has replacement speakers for 90% of the TV sets now in the field. Permoflux Corp., 4900 W. Grand Ave., Chicago 39, Illinois.—RADIO & TELEVISION RETAILING.

## UTC ADAPTOR TRANSFORMER

The MA-1 Adaptor is a new input transformer for matching low impedance mikes, pickups, etc., to high impedance circuits. The unit matches any source from 50 to 500 ohms impedance to grid. A standard jack receptacle for input and jack plug for output are provided to simplify installation. Stated fidelity of the unit is 50-10,000 cycles. For additional information write United Transformer Co., 150 Varick St., New York 13, N. Y.—RADIO & TELEVISION RETAILING.

## Telex HEADSET

Twinset is a twin-receiver headset weighing 1.6 ounces which can be adjusted to fit any size or shape head. Pressure and chafing of the ear is eliminated because of styling of the receivers. A single-cord connection replaces the Y-cord formerly used in such devices. Telex Inc., Telex Park, Minneapolis 1, Minn.—RADIO & TELEVISION RETAILING.

## Cima RESISTORS

A complete line of power wire-wound resistors of vitreous enamel construction is available in a variety of types, including adjustable tap, fixed tapped, ribbon-wound, cartridge type, etc. Full specifications for different types and sizes may be had in 4-page folder by writing Cima Corp., 91 Boylston St., Jamaica Plain 30, Mass.—RADIO & TELEVISION RETAILING.

## Chicago ISOLATION TRANSFORMERS

Three isolation transformers, with 50, 150, and 250 VA capacities are now available, suitable for adjusting high or low line voltages, and for eliminating shock hazard associated with AC-DC equipment. Complete description and prices may be had from Chicago Transformer Division, Essex Wire Corp., 3501 W. Addison St., Chicago 18, Ill.—RADIO & TELEVISION RETAILING.

# VEE-D-X

provides everything you need

**SINGLE SOURCE**

Antennas, Masts, Towers  
Chimney, Vent Pipe and all Angle Mounts  
Guy Cable, Guy Rings and Collars  
Turnbuckles, Thimbles, Cable Clamps  
Lightning Arresters  
Transmission Line

**FOR BETTER TV & FM INSTALLATIONS**

## Now VEE-D-X HAS AN ANTENNA FOR EVERY NEED

**SUPER RD-13**—The champion of all antennas. Holds every record for long distance reception. A four bay, full wave, thirty-two element stacked array.

**JUNIOR JR-13** — A fine performer, yet moderately priced. Two bay, full wave, sixteen element stacked array, adequate for most fringe areas.

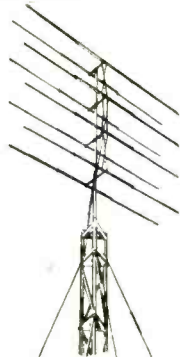

**SECTIONAL TOWER** — 10' and 20' sections for mounting antennas up to 140'. Sections shipped assembled and painted. Fast low cost erection on ground or roof.



**LIGHT WEIGHT MAST** — Nothing finer — or faster to install. Sturdy magnesium mast in 12' or 20' lengths. Rotates with guy cables installed.

**SKY MONITOR DGA-12** — For outstanding results in near fringe and primary areas. Broad band antenna with tunable Q section. Extremely flat response. Low in cost.



**CHAMPION RDH**—A sixteen element full wave, four bay, stacked array, cut especially for any one of channels 7 to 13. Outperforms any other high channel antenna.

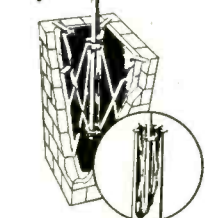
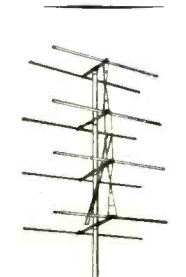

**CHIMNEY MOUNT** — The finest chimney mount available. Fits any opening — round, square or rectangular from 4" to 22" for 1", 1 1/8", and 1 1/4" masts.

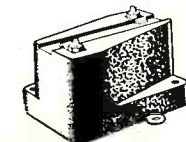

**LIGHTNING ARRESTER** — No need to cut transmission lines. Does not disturb impedance match. High dielectric, low loss.

## Introducing THE NEW YAGI

sensational low cost, high gain antenna

The new VEE-D-X, RDY Series, a four element beam cut for each particular channel. Here is an antenna which is the most sensational single channel performer yet to be manufactured. VEE-D-X engineers have attained astonishing results in producing an array combining every desirable characteristic necessary for optimum performance.

**New all angle mount**  
Particularly suited for mounting on side of house near a window for manual rotation of antenna. Designed to clear overhang of eaves. Also excellent for flat or pitched roofs as shown below.

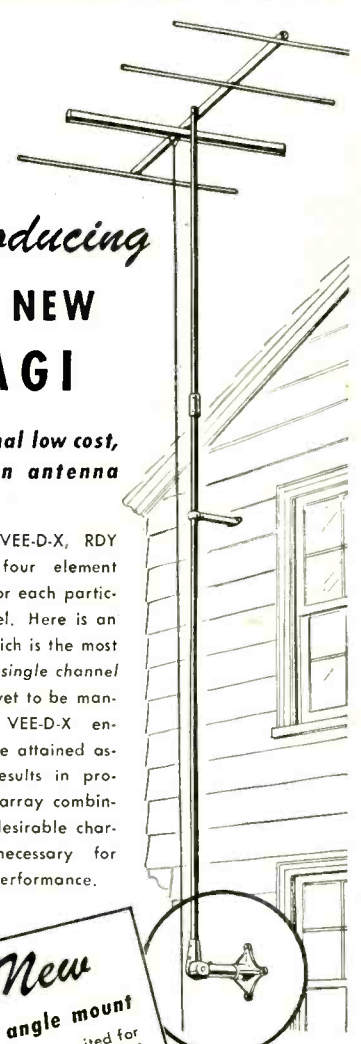

LaPOINTE-PLASCOMOLD CORP., Unionville, Conn., 4  
Gentlemen: Send me new literature and prices on the complete line of VEE-D-X television accessories.

Name \_\_\_\_\_  
Company \_\_\_\_\_  
Street \_\_\_\_\_  
City \_\_\_\_\_ Zone \_\_\_\_\_ State \_\_\_\_\_

**VEE-D-X means video distance**

**Naturally**  
the news is spreading  
like wildfire

# The Anchor TV-Pre-Amplifier

**IS NOT JUST  
ANOTHER BOOSTER**

It's a thoroughly engineered and beautifully styled product  
Read this unsolicited statement by an independent service engineer



It does have more USEABLE gain than any other "booster" I have seen, yielding snow-free pictures under the most difficult conditions.

Johnson & Elliott  
Monticello, N. Y.

**It Really Performs  
As Claimed**

Where You Need a Pre-Amplifier, Install Anchor for the Best.  
IT'S NEW, DIFFERENT because:

- Simultaneous iron core tuning of grid and plate circuits.
- 2½ times average gain (Voltage Ratio).
- Guaranteed coverage of low and high TV-Band.
- 4 mc minimum Bandwidth on all channels.
- Impedance matching to receiver.

List Price  
**\$37.50**

We are also happy to announce,  
that our Indoor Antenna,

## SUPER-TENNA

**IS NOW AVAILABLE**

Better match—Clearer, brighter pictures  
**WITH THE SUPER-TENNA**  
over counter sales now possible

List Price **\$8.95**      EFFICIENT  
COMPACT



**COMPARE THESE OUTSTANDING FEATURES**

- The Super-Tenna is adjustable from position illustrated to a length of 48 inches.
- It is high gain folded Dipole—300 ohm match on any TV-frequency.
- Unique in design—beautifully styled, will not overbalance in any position.
- Fits on top of Pre-Amplifier, Receiver or nearby objects—Base removable for wall mounting.

HERE ARE TWO SURE-FIRE ITEMS TO INCREASE TELEVISION SALES  
AVAILABLE AT LEADING JOBBERS. IF YOUR JOBBER CANNOT  
SUPPLY YOU, WRITE US FOR NEAREST JOBBER.



**ANCHOR**  
RADIO CORP.  
2215 S. St. Louis Ave.  
Chicago 23, Ill.

## International CLOCK TIMER

Completely automatic radio clock timer. Known as the RC-3021, this timer, featuring a "slumber switch", automatically performs two distinct operations, being a combination of two independent timers operated by one motor. One timer is a manual "on", automatic "off" interval timer (slumber switch) to control an interval up to 60 minutes. The other is an automatic "on" timer to "catch" a program at any time within 12 hours. International Register Co., 2614 W. Washington Blvd., Chicago 12.—RADIO & TELEVISION RETAILING.

## Grand Utilities RADIO BAR CHEST

Combination of chest, seat and bar with a place to hold a radio. Bar tray and stand folds up and fits into the chest. Radio is held in place with adjustable elastic straps; any size can be strapped in. Unit without bar accessories sells for \$29.95, with glassware, etc., for \$39.95. Radio is not included. Grand Utilities Corp., 201 So. Second Ave., Mount Vernon, N. Y.—RADIO & TELEVISION RETAILING

## Custom Built RADIO CABINET

Ready-built cabinet of modern Chinese design for dealers to use with special order equipment. Upon receipt of measurements firm also builds any cabinet to dealer's specifications. Stephen Nemes, 2631 Lehmann Court, Chicago 14, Ill.—RADIO & TELEVISION RETAILING

## Acro Wood TELEVISION TABLE

Television tables made of maple and birch, available in walnut or mahogany finish. Models available to fit any television set on the market. Acro Wood Products Corp., 47 Watkins St., Brooklyn 12, N. Y.—RADIO & TELEVISION RETAILING

## Tel-Craft TELEVISION CABINET

Cabinet shown designed for use with RCA models using 10-inch and 12-inch picture tubes. 27½ inches wide, 19 inches deep, 20 inches high. Cabinet of walnut or mahogany, drilled for shafts, wired for dial lighting and ready for installation. Complete with necessary hardware and instructions, priced at \$79.00. Tel-Craft Co., 108 Havemeyer St., Brooklyn 11, N. Y.—RADIO & TELEVISION RETAILING

## UST COMMERCIAL TELEVISION

Commercial television models for use in public places where large crowds view television. One unit has screen of 675 square inches, 30 by 22½ inches; another model has 475 square inches of viewing screen. The sets tune in 13 channels and have 26 tubes plus 6 rectifiers. FM radio is included in the new models. The larger set is 78 inches high, 44 inches wide, and 24 inches deep and lists for \$1795. The smaller unit is 69 inches high, 42 inches wide and 19 inches deep and sells for \$1595. United States Television Mfg. Corp., 3 W. 61 St., New York 23, N. Y.—RADIO & TELEVISION RETAILING

## Flextron MAGNIFYING LENS

Five new suspending lenses in line. Shown is No. 3, round. Available in clear or blue, lenses adjust either up or down for proper focus. Electro-Steel Products, Inc., 112-14 N. Seventh St., Philadelphia 6, Pa.—RADIO & TELEVISION RETAILING

Ask For Model 209

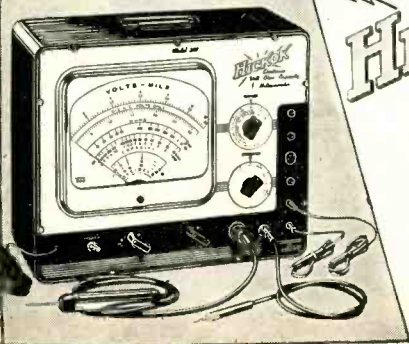

# HICKOK

Electronic

**VOLT—OHM—CAPACITY  
MILLIAMMETER**

*Large Laboratory Size*

Measures resistance (.1 ohm to 10,000 meg-ohms), capacitance, inductance, current, voltage, both AC and DC.

**THE HICKOK ELECTRICAL INSTRUMENT CO.**  
10923 Dupont Avenue • Cleveland 8, Ohio

## Names in the News

Camfield Manufacturing Company, of Grand Haven, Michigan, announced the recent appointment of R. H. Sutcliffe as district manager of the Atlantic States territory, which includes the states of Pennsylvania, Virginia, Delaware, District of Columbia, Maryland and New Jersey.

Alfred S. Gartner has joined Cornell-Dubilier Electric Corporation sales organization as assistant to Arthur Williams, sales manager of the capacitor manufacturing division.

Walter T. Moreland has been appointed to succeed William E. Skinner as Arvin district manager for Texas and the southwestern territory according to Gordon T. Ritter, director of sales for the Arvin division of Noblitt-Sparks Industries, Inc.

Appointment of Albert G. Bill to the television engineering staff of Noblitt-Sparks Industries, Inc., which will introduce its new television receivers later in the year, has been announced by Ben H. Irwin, chief engineer of the company's radio division.

The appointment of Kendrick H. Lippitt as chief engineer of Technical Appliance Corporation, manufacturers of Taco radio and TV antennas at Sherbourne, N.Y. is announced.

J. W. Bostwick, sales manager of the Electric Refrigeration Division of Servel, Inc., Evansville, Indiana, has announced the appointment of James A. Madden to the position of district manager of the southern Atlantic territory.

## Setchell-Carlson Moves

Setchell-Carlson, Inc., New Brighton, Minn., has announced removal of its company to its new factory at New Brighton. The following officials of the company remain the same: B. T. Setchell, president and chief electronic engineer; A. P. Setchell, vice-president and office manager; D. C. Carlson, secretary-treasurer and chief mechanical engineer; D. L. Johnson, sales manager.

## Remington Lowers Price

In an effort to institute wider distribution, The Remington Radio Corp., White Plains, N. Y., has temporarily reduced the retail price of its table model "1950" television from \$495 to \$395. The set features a 12" picture tube, automatic gain control and the Remington automatic picture stabilizer.

## N. Y. "Reps" Meet

The N. Y. chapter of the Representatives, at its monthly meeting, discussed the difficulties encountered by salesmen carrying heavy sample cases and unable to park near the point of call, in New York City. The secretary was instructed to write to the police commissioner requesting whether special identification could be issued permitting these men to park for short periods in restricted areas without being subject to fines.

Century's FIRST with...



# VISUAL TUNING

It's the *natural* thing to do. You tune by eye instead of ear. You tune the picture, not the sound. Now you can see what you're doing. Customers are thrilled with the new ease of tuning and with Century's superb picture quality.

ITI's new Century line of home receivers brings you advanced circuit design—superior performance, fewer service calls. 16" remote control units for the class market—12" receivers for the mass market. Semi-automatic tuning with just two picture controls. Magnificent Swedish modern cabinets. Lower power consumption—about 33% less. A complete\* line.

If you want to make longer profits and avoid tie-in buying . . . stay ahead of competition with ITI, the vision in television.

\*The line includes: Remote Control Combination with 16" viewing unit (Model 226) and chairside TV control unit with AM-FM-Phonograph (Model 234); Table top Model (Model 521); Console (Model 221); Console with doors (Model 421); and 5-way Combination with AM-FM-TV, plus Regular and LP automatic phonograph (Model 321). All available in dark or blond mahogany.



**INDUSTRIAL TELEVISION INC.**  
359 Lexington Avenue  
Clifton New Jersey

IT'S HERE

# High-Fidelity Rauland 1825 Phonograph Amplifier

## TOPS FOR CUSTOM INSTALLATION



1825 Amplifier  
with cover



**± 1 DB**  
**40 TO 20,000 CPS**  
**25 WATTS OUTPUT**  
(5% harmonic distortion)

Underwriters Listed

### Boost Type Tone Controls

Two separate controls provide plenty of Bass and Treble boost; permit adjustment for correct tonal response to suit individual listening taste.

### Plug-in Equalizer

Designed to compensate for variations in response of phono pickups. Proper equalizer is available for every type of pickup.

### 5-Position Frequency Cut Off

Eliminates needle scratch and noise—in five steps of frequency cut off. Restores original clarity to favorite recordings.

### Dual Volume Controls

Auxiliary volume control on power amplifier prevents "cramping" of main volume control, and improves signal-to-noise ratio.

### EXCLUSIVE! Detachable Remote Preamplifier

Preamplifier is detachable; mounts in any position to meet mechanical requirements of any custom installation. Compact; only 2 3/4 x 2 3/4 x 1 1/2". Unlimited flexibility for custom-builders.

### Dual Input Selector

Two-position switch selects permanently connected phonograph and auxiliary inputs to Preamplifier.

**Y**ou'll dominate the custom-installation market with the new RAULAND 1825 High-Fidelity Phono Amplifier. It's out in front with unprecedented mechanical installation features. Amazing in performance—it brings real tonal magic out of any recording, regardless of condition. There's nothing comparable on the market for features and value. Available for immediate delivery from stock. Get the full details today!

See your RAULAND-BORG Distributor for full information on the RAULAND 1825 High-Fidelity Phono Amplifier. Get your profitable share of the big market for quality custom installations with this fast-selling unit. It's unbeatable for advanced features and value custom-builders appreciate and want.

Electroneering is our business

SOUND  
EQUIPMENT

# Rauland

INTER-  
COMMUNICATION

RAULAND-BORG CORPORATION • 4247 N. KNOX AVE. • CHICAGO 41, ILL.

For Quality Pictures —

# ZETKA

12 1/2" and 15" Tubes

For rich contrast, freedom from ion stain, long life and dependability there is no better tube. Limited quantity available now. Write or phone immediately as shortages are likely to recur.

ZETKA TELEVISION TUBES, INC.

131 Getty Ave., Clifton, N. J.

Phone: PAssaic 2-9095.

## TV Servicing

(Continued from page 68)

an unnecessary service call. Furthermore, he might explain at the beginning, or have his installer do so, that when such a situation arises the customer should try other stations before assuming that the set has broken down. If the quality of a program suddenly takes a turn for the worse, a call to the station might reveal a temporary trouble.

In discussing the relative merits of different sets, the dealer should try to stay on firm ground and not lay the groundwork for future misunderstandings. Often over-enthusiastic salesmen are actually guilty of misrepresentation.

A shopper recently reported two conflicting sales points which came up in connection with a particular brand. Dealer "A" said that he had discontinued this brand because the picture had insufficient brilliance in comparison with the brand he now carried. Dealer "B" stated that he *only* carried the brand in question because he had found it to be the only set with a picture of sufficient brightness. Obviously one of these dealers was in error, but actually they probably both were. The writer has yet to see a set with insufficient brightness for normal viewing within a normal range from the station.

### Size of Picture

Over and above the quality of workmanship and materials that different manufacturers may put into a set, the principal observable differences are: size of picture, style of cabinet, inclusion of additional features such as radio and phonograph, quality of the audio system (influenced partly by the size of the loudspeaker), and stability of the picture (that is, absence of vertical rolling and horizontal tearing).

With respect to size of picture, the dealer should approach this subject frankly and clearly. Two sets with the same size picture tube are not going to have radically different sized pictures unless one of them does so at the expense of losing some of the transmitted picture (see New Developments in TV Picture Sizes, February issue RADIO & TELEVISION RETAILING). If any special devices are used to get larger pictures, the customer should be so informed.

One of the strongest selling points to advance in TV is the dealer's own service department. Since any particular brand set may be purchased in several different stores, anything extra the dealer may offer in the way of experience, know-how and service is important in swinging the sale his way.

All in all, it will be found that intelligent, honest, "clean" selling will prove the most profitable since the customer is most likely to stay satisfied with his set.

# L P Changers

(Continued from page 94)

at N because this member is statically balanced. The pressure of the pawl against the stop lever, at D, consists of the difference in weight between the front end and back end of the pawl. The design as shown results in a trip device as frictionless as is practical to manufacture on a mass basis.

In actual use the total friction is so light that it is possible to trip this mechanism by a puff of breath on the "L" end of the lever.

This velocity trip is used on all post-war models of record changers manufactured by the Webster-Chicago Corporation, and is one of the most important features contributing toward the successful playing of LP records.

## GE District Manager



Grady L. Roark, shown, has been appointed New York district manager for the General Electric Company's Electronics Department, announced Arthur A. Brandt, general sales manager.

## Names Sales Reps

Radio Merchandise Sales, Inc., 350 Westchester Ave., New York 55, has named the following representatives to cover its line: Leon Adelman, 25 Chittenden Ave., New York City; Norman R. MacInnis, 53 Youle St., Melrose, Mass.

## Garod "Tele-Zoom"



Introduction of Garod "Tele-Zoom" television in the Boston area is discussed during a dealer showing in the showrooms of Merchants Distributors, Inc., Boston. From l. to r. are: James Hayes and Max Katz, president, Merchants Distributors; David Malkiel, Malkiel Advertising Agency; Louis Silver, executive vice-president, Garod Electronics Corp., Brooklyn, N. Y.

# NOW...

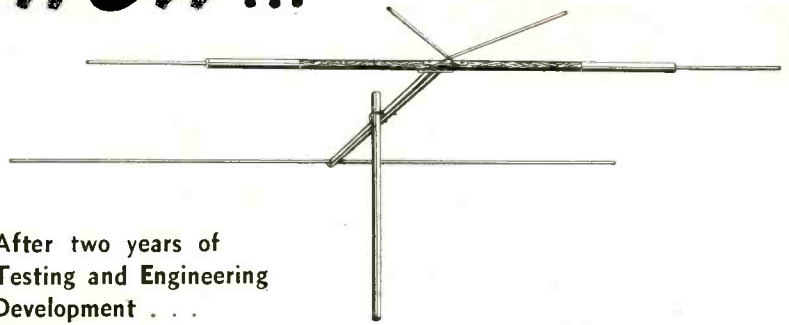

After two years of Testing and Engineering Development . . .

S/C Laboratories Presents The New . . . Low Cost

## TYPE BR ANTENNA

with

"BROAD RESPONSE"

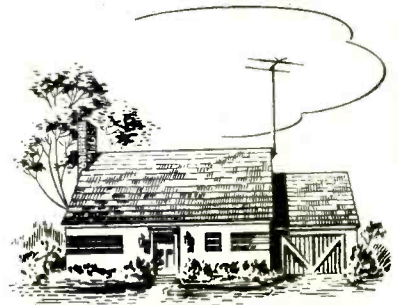

### Check These Features . . .

- Low Cost!
- Simplified Assembly (no loose hardware)
- Covers All TV Channels and FM Bands.
- High Front-to-Back Ratio insuring minimum of "ghosts"
- Unidirectional
- Broad Band Response
- Weather Proof
- Scientifically manufactured and Tested
- Light Weight Construction
- Can be used with 300 ~ Balanced line of 72 ~ coaxial cable.

# S/C LABORATORIES

39 GEORGE STREET

NEWARK 5, N. J.

## WHY IS OPTO-VISION RAPIDLY BECOMING THE FASTEST SELLING QUALITY FILTER IN AMERICA?

No. 1—OPTO-VISION is the only optically approved TV filter. The soothing green optical properties has proven so comforting to the eyes that televisioners recommend it unsolicited.	Size	List
No. 2—Unusual liberal discounts justify OPTO-VISION dealers to recommend it without hesitation toward a substantial profit and to acquire a satisfied customer.	#7 for 7" tube	\$ 6.00
	#10 for 10" tube	10.00
	#12 for 12" tube	12.00
	#14A for Philco Model 1150	14.00
	#14B for Philco Model 11450	16.00
	#15 for 15" tube	15.00
	#16 for 16" RCA tube	18.00
	#20 for 20" tube	20.00
	A for Zenith round 10"	12.00
	B for Zenith round 12"	15.00

DISCOUNTS: Orders for 1 to 11 Filters, 50%; 12 or more Filters, 50% plus 10%; Special Cash Discount, 5%. Shipped PP, FOB, NYC.



TELEVISION FILTER CO., 225 West 34th St., New York 1, N. Y.

## CHIMNEY MOUNT PAM-5

Fast, one-man installation on any type chimney. Holds mast  $\frac{3}{4}$ " to  $1\frac{1}{2}$ " Heavy gauge steel, cadmium plated. Two-section construction for greater safety, rigidity and strength.

**\$450**

List per pair

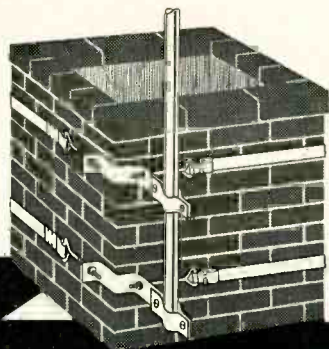

There's a Phoenix Speed

Mount for every installation

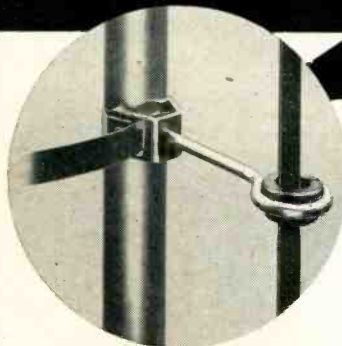

### STAND-OFF INSULATORS

Attaches to any size mast in 10 seconds—just pull strap through a turn screw eye. Eliminates swinging lead-ins with broken wires. A must for every installation.

**25¢**  
ea. List

AT LEADING JOBBERS AND DEALERS — SEND FOR LITERATURE

**PHOENIX ELECTRONICS, INC.**

LAWRENCE, MASS.

Highest possible forward gain!

**NEW!**

## PHILSON'S LOW PRICE TELEVISION ANTENNAS

- HIGHEST FORWARD GAIN ON HIGH AND LOW BANDS
- SUPER SENSITIVE FOR LONG DISTANCE RECEPTION
- INDEPENDENT ALL-DIRECTIONAL ORIENTATION
- NON-CONDUCTIVE, WEATHER-PROOFED WOOD CROSS-BAR

This high-quality and low-priced antenna is much more sensitive for perfect TV reception in poor signal locations and fringe areas. Supplied with U bolt and profile for easy rotation and speedy installation. Wooden cross-bar eliminates possible leakage from antenna to ground.

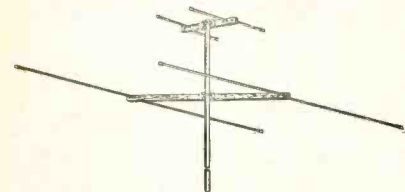

No. 33 Single dipole 72 ohms. High and low frequency antennas with reflectors. Semi-assembled with all bolts, washers, and nuts in place—no loose hardware. Packed 1 to a box.

#### THESE ANTENNAS ARE ALSO MADE IN FOLLOWING STYLES

- No. 18 Stacked single dipoles, low frequency, and reflectors.
- No. 19 Stacked folded dipoles, low frequency, and reflectors.
- No. 23 Single HIGH frequency dipole antenna with reflector.
- No. 24 Folded HIGH Frequency dipole antenna with reflector.
- No. 28 Stacked single, high frequency with reflectors.
- No. 29 Stacked folded, high frequency with reflectors.

DISTRIBUTORS WANTED for profitable territories still open.

WRITE FOR CATALOG 4-TR showing complete line of TV-FM antennas



No. 34 FOLDED DIPOLE 300 ohms. High and low frequency antennas with reflectors. Semi-assembled with all bolts, washers, and nuts in place. No loose hardware.

**PHILSON** MANUFACTURING CO., INC.

156 Chambers Street, New York 7, N. Y.



## Protelgram

(Continued from page 91)

springs in place. The light shield is on top of the tube (180 degrees from the 2nd anode cup) and will shield the tube face from the corrector lens in the top of the box. The 2nd anode lead is inserted in the cup, held in place by the tight fit of its moulded insulation and a spring in the end of the lead.

The tail-piece is now ready to replace in the box. Watch clearance between the tube and the elliptical hole in the inclined mirror when inserting the tail-piece. Rotate to the right to stop, and tighten the four thumb-screws "M" to lock in position. The bottom of the end-plate should be parallel to the bottom of the box when this operation is complete. The tube socket will, of course, be attached at this point, and all other interconnecting cables should be checked.

### Leads

The leads connecting the unit to the TV chassis will be explained in the receiver Service Notes, but briefly they are as follows: 2 each from the horizontal and vertical deflection coils in the yoke, to the appropriate output stages of the receiver, usually through the centering controls; 2 from the focus coil, usually one to ground and one to the power supply through the focus control; and one additional ground lead. The 3NP4 socket has 5 pins (#1 grid, #2,4 filament, #5 cathode, and #3 ground) with a locating key. The 2nd anode lead comes from the Protelgram high voltage unit, which is supplied with filament and B plus voltages from the receiver. Sometimes a separate low voltage power supply is provided due to the importance of good regulation to the high voltage unit.

With the tube installed and cables connected, the set will be turned on and tuned in, and adjustments made while looking down at the inclined mirror (rather than observing the screen in the cabinet): adjustments for centering and size. Optical adjustments are made on the tail piece as follows: slightly loosen the five thumb-nuts "N." "O" is overall focus—watch center of picture only and bring into focus. "H" is horizontal focus—look at sides of picture only and bring both sides in focus equally well. "V" is vertical focus—look at top and bottom and bring in focus equally well. Re-check "O" after adjusting "H" and "V." Then tighten the thumbnuts "N."

If the picture on the viewing screen is not positioned properly with respect to the frame, it may be canted by changing the position of the three tilt-screws "T" (two visible in view 1, the third is in the rear). In the event that more canting is necessary, loosen the four thumb-screws "M" and rotate the tail-piece slightly.

The corrector lens is covered with a protective glass, so it may be wiped  
(Continued on page 113)



## Present Philco Officials With Federation Award



James M. Skinner, center, vice-president, service and parts, Philco Corp. is presented with a plaque by the Federation of Radio Servicemen's Associations of Pennsylvania. The award expressed the appreciation of the group for Philco's television training program for servicemen. Shown at the meeting are (l. to r.): Lawrence H. McGuire, manager, John A. Blessing Co., Philco distributor for central Pennsylvania, Harrisburg; Robert W. Riedy, FRSA vice-chairman, Allentown; Kenneth Kenyon, general manager, Philco Service Division; Leonard Helk, Scranton; John Pell, Philco television service manager; Mr. Skinner; Clifford H. Arthur, Jr., Philco sales representative; David Krantz, FRSA chairman and toastmaster at the dinner, Philadelphia; John Morgan, Philco field service representative; and John G. Rader, secretary-treasurer, FRSA, Reading.

## Astatic CRYSTAL CARTRIDGE

Astatic LQD Cartridge uses two separate, independent needles, one with one-mil tip radius to play the new LP records; the other with three-mil tip radius for standard recordings. These are the Astatic "Q" and "Q-33" needles, readily obtainable in the field. A gentle pry with a penknife or small screw driver lifts either of these special needles from its snap-in position in the cartridge, without removing the cartridge from the tone arm. Gentle pressure with the tip of a knife blade clicks the new needle into place. Removing or replacing one needle does not disturb the other. The LQD Cartridge has a stamped aluminum housing, frequency response 50 to 7,000 c.p.s. Output voltages are 1.2 at 1,000 cycles with 78 RPM Audio-Tone Test Record, 0.75 with 33 1/3 RPM Columbia 281 Test Record, and 0.5 with 33 1/3 RPM Columbia 103 Test Record. Recommended needle pressures are 15 grams for 78 RPM and six to eight grams for 33 1/3 RPM. Astatic Corp., Conneaut, Ohio—RADIO & TELEVISION RETAILING.

## Hunton TV MAGNIFIERS

New prices have been announced for the Hunton magnifying lenses illustrated in the February issue of RADIO & TELEVISION RETAILING. The new list is as follows: De Luxe 12-inch, \$32.95, Azure 10-inch, \$27.50, Regular 10-inch, \$26.25, Broadview 10-inch, \$24.95, Circular Z10-inch, \$29.95, Azure 7-inch, \$21.00, and Broadview 7-inch, \$19.95. Hunton Plastics Co., 9 So. Van Brunt St., Englewood, N. J.—RADIO & TELEVISION RETAILING.

**tradioVision**  
PRESENTS  
"The Champion"  
REMOTE CONTROL TELEVISION

New Model Available  
In Chassis Form For  
Custom Installations.

**PICTURE SIZE**  
**4 ft. x 3 ft.**

**COMPACT REMOTE CONTROL UNIT**  
Height 9" • Width 13" • Depth 8"

Dealer inquiries invited.

**PIONEERS IN DEVELOPMENT  
OF RADIO AND TELEVISION  
FOR PUBLIC LOCATIONS**



**TRAD TELEVISION CORP.**

NEW YORK DISTRIBUTORS: TRADIOVISION OF NEW YORK, INC. • 377 4th AVE., NEW YORK 16, N. Y.

MFRS. OF RCA LICENSED TELEVISION  
1001 FIRST AVE., ASBURY PARK, N. J.

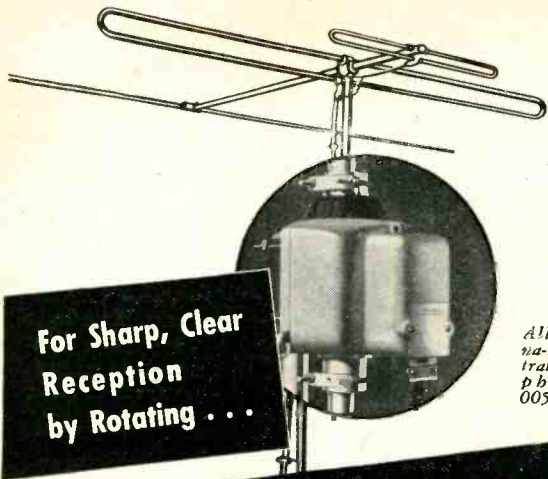

For Sharp, Clear Reception by Rotating . . .

*Alliance Tenna-Rotor illustrated with Amphénol 114-005 antenna.*

**AMPHENOL ANTENNAS GIVE HIGHEST GAIN!**

**AMPHENOL**

Where TV broadcasting stations are at wide angles from point of reception and re-orientation of the antenna is required to maximize each station, Amphénol television antennas provide the greatest gain by virtue of the in-line high and low band folded dipoles which beam in a clean, narrow directional pattern. The high front-to-side and front-to-back ratios not only provide maximum signal pickup in the exact desired direction, but also secure against any interference from an unwanted direction.

Durable, sturdy, aluminum construction withstands high wind and ice loading combined.

Install Amphénol in single bay or stacked array.

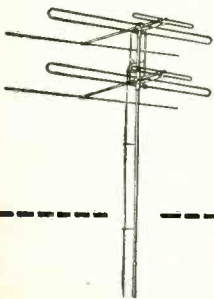

*Illustrated at left is the standard Amphénol television antenna shown in stacked array (Model 114-302) for added db gain in fringe areas . . . or each bay may be individually oriented.*

*Model 114-005 at right is the standard Amphénol All-Channel TV Antenna with brilliant reception on all channels in both bands.*

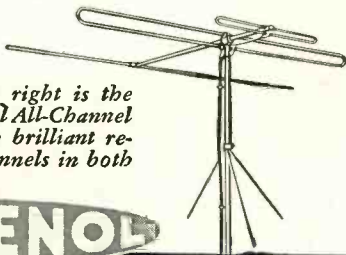

**AMPHENOL**

**AMERICAN PHENOLIC CORPORATION**  
1830 SO. 54TH AVENUE • CHICAGO 50, ILLINOIS

## The Most Complete Line of Antenna MOUNTS

- A mount for every need
- Lowest priced in the industry
- Ruggedly constructed

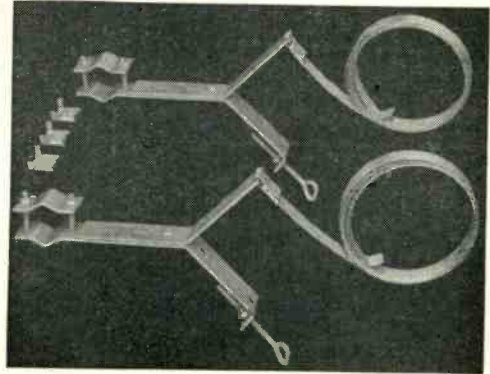

Model TVB-105  
Chimney Mount

List price  
\$4.25 set

MODERN-AIRE MOUNTS are durably constructed of  $\frac{1}{8}$ " zinc plated steel; completely assembled ready to mount; welded and bolted together for superior strength; positive locking action; all models come in pairs for maximum antenna rigidity. Boxed in sets of two.

LIST PRICES OF OTHER MODELS (per set)

TVB-109	.....\$3.95
Vent Mount	
TVB-112	..... 4.95
12" Wall Bracket Mount	
TVB-106	..... 3.25
Corner Mount	
TVB-108	..... 4.25
8" Wall Bracket Mount	
TVB-118	..... 5.95
18" Wall Bracket Mount	

Write for catalog sheet. MODERN-AIRE MOUNTS are available at your jobber. If he cannot supply you, write for nearest jobber.

Some territories still available for representation.

**MODERN-AIRE MFG. CORP.**

4434 W. Roosevelt Road  
Chicago, Illinois

**PREMAX**

## Covers All TV Channels

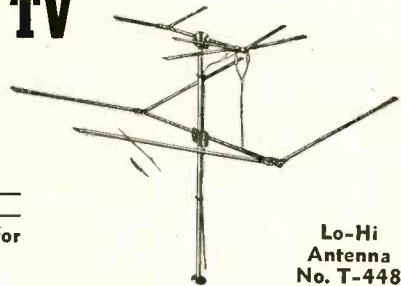

Lo-Hi  
Antenna  
No. T-448

Low Cost—Easy to Erect—  
Eliminates Interference—  
Stops "Trouble Calls" for  
Servicemen.

An Antenna that gives sufficient signal response to minimize the importance of the otherwise difficult task of perfect impedance matching. Works equally well on any channel from 2 to 13. Tests show a consistently relative response of about 4 DB on all channels.

Can be supplied as a lo-hi assembly, or in individual units for low or high frequency. This antenna can at any time be converted to all-frequency reception by the addition of the Premax Conversion Unit.

Sturdy . . . easy to erect . . . yields good profit for the service man making installation . . . minimizes "trouble calls."

Low-Frequency Unit No. TA-4481  
Hi-Frequency Unit No. TB-4482  
Conversion Unit No. TC-4483  
High-Low Assembly No. T-448

SEND FOR TV BULLETIN

**PREMAX PRODUCTS**  
**DIVISION CHISHOLM-RYDER CO., INC.**

4906 HIGHLAND AVENUE

NIAGARA FALLS, N. Y.

# Protelgram

(Continued from page 110)

without danger of spoiling the lens. This glass should be kept free of dust.

The high voltage unit is essentially a 1000 cycle oscillator (6SR7) feeding a saw-tooth voltage to the 6BG6 driver tube, which feeds the high-voltage rectifiers through a transformer. The high voltage transformer and the three rectifiers in a voltage tripler arrangement are sealed in oil inside a can within the high-voltage unit box. This can will be replaced as a unit in case of failure, and only the 6SR7 and 6BG6 and associated circuits will be available to the servicer. Voltage and resistance values for checking will be available in the receiver service notes. It is to be noted that regulation in the low-voltage power supply to this unit is essential.

It will be found that TV receivers associated with Protelgram units will be similar to 10-inch sets now in use with the exception of the following: 1) provisions for a somewhat higher video voltage (up to 70), 2) wider focus current range to allow for greater degree of adjustment desired for a projection tube, 3) a well-regulated 350V.-50MA DC source for the 25KV high voltage unit, and 4) a protection circuit to prevent screen burns on the projection tube in cases of sweep voltage failure. The latter is subject to variation with the manufacturer, but will usually consist of a control tube sensitive to the presence of current in the deflection yoke or deflection amplifiers, and which in case of failure would bias off the picture tube.

## GI 3-Speed Motor

New motor will permit playing of conventional 78 RPM records, 33 $\frac{1}{3}$  RPM records, and the new 45 RPM discs.

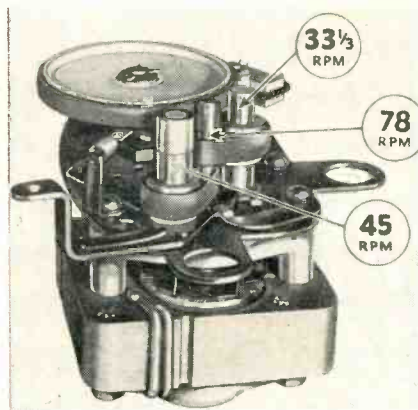

The three turntable speeds are secured by ingeniously positioning various spindles in contact with the idler wheel.

Shifting is accomplished by movement of a detented shift lever. Manual motor assemblies using 6 $\frac{1}{2}$ ", 8" and 9" turntables are available in which the three-speed principle is incorporated. General Industries Co., Elyria, Ohio—**RADIO & TELEVISION RETAILING.**

RADIO & TELEVISION RETAILING • April, 1949

★ **QUALITY**  
★ **PRICE**  
★ **FEATURES**  
found in no other mounting bases.

The New South River  
**Duo-Mount Antenna Base**  
Model No. DM 37 (Pat. Pending)

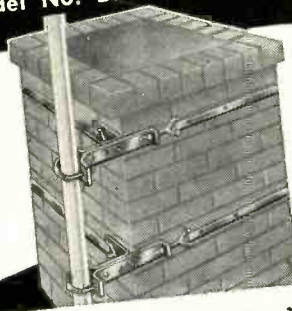

Holds antennas from 5/8" to 1 1/2" O. D. Made of riveted steel in hot dipped, everlasting galvanized finish. Features special "U" bolt.  
List Price **\$4.50** Individually Boxed

The Original South River  
**Chimney Mount Antenna Base**  
Model No. SR 10 (Pat. Pending)  
The Aristocrat of Antenna Bases

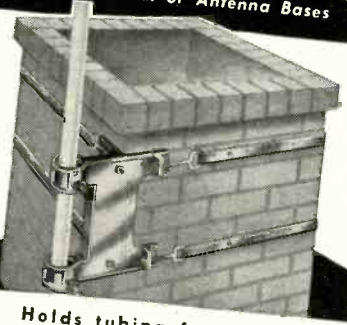

Holds tubing from 1/2" to 1 1/2" O. D., pipe from 1/4" to 1 1/4". Exceptionally durable. The four eye bolts enable straps to be tightened evenly. Also available in two sections if requested.

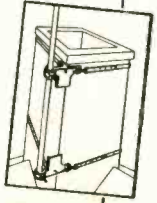

List Price **\$7.50** Individually Boxed

Both mounts can be installed in minutes by one man with no special tools.

See your jobber or write to  
**SOUTH RIVER**  
Metal Products Company, Inc.  
South River, New Jersey

... for

**INCREASED**  
**SALES**  
and  
**PROFITS...**



DeWald C-800 FM-AM Receiver

in  
**RADIO**  
and  
**TELEVISION**

for  
**SOMETHING**  
**BETTER,**  
it's

**DEWALD**



DeWald CT-102 High Definition Television

During the NEDA SHOW  
in Chicago, May 16-20  
the new DeWald line  
of **TELEVISION** and **RADIO**  
will be on display at the  
Blackstone Hotel

**Be sure to see it!**

**DEWALD RADIO MFG. Corp.**  
35-15 37th Ave., Long Island City 1, N. Y.

# CHECK!

- ★ Cold inorganic-cement coated
- ★ Won't blister, peel, flake, crack
- ★ Stands up under severe overloads
- ★ Fixed and adjustable. 5 to 200 watts
- ★ Wide selection of resistance values



## YES INDEED, GREENOHMS ARE TOUGHER!

★ Those green power resistors you find in better-grade TV sets, oscillographs, test instruments, transmitters and industrial equipment, are GREENOHMS. Take a tip! For your "stay-put" jobs

—where you can't take a chance with component breakdowns—when you don't want to lose your profit by going back again—use GREENOHMS. They'll never let you down! And they cost less!

Ask our jobber for Greenohms.  
Try them once!  
Latest catalog on request.



# Controls and Resistors

CLAROSTAT MFG. CO., INC. • DOVER, NEW HAMPSHIRE • In Canada: CANADIAN MARCONI CO., LTD. Montreal, P. Q., and branches

## COAST TO COAST TV WITHIN FIVE YEARS

Coast to coast TV within five years predicted by NBC executive Carlton D. Smith. By July 1, 1949, Wilmington (Del.) will join the cable network, Smith said, Hartford (Conn.) connections will be available in August, a Boston to Providence channel will be provided in September . . . and in the last quarter of the year service is due in Rochester, Erie, Lancaster, Utica, Syracuse, Columbus, Dayton and Cincinnati. By January 1, 1950, a Los Angeles to San Francisco leg will have been added and in the first quarter of 1950 Harrisburg and Norfolk will be connected to the cable, and a leg from St. Louis to Memphis will have been added. Indianapolis will be added in March and Fort Wayne in May. Johnstown, Reading and York will be connected during September, Louisville in October, three westbound circuits out of Chicago will be extended to Des Moines and to St. Paul-Minneapolis during the fourth quarter of 1950. The Davenport tri-city area will be served by this leg.

## Increased FM Production

Latest radio set manufacturers' figures continued to show increased production of FM receivers while sets having AM-only facilities are declining in output, according to an analysis of overall radio set production figures made by the FM Association, 526 Dupont Circle Bldg., Washington 6, D. C.

## METALACE offers 17 Different Types of Mounts

THE ONLY FULL LINE in the industry permitting you to obtain all your equipment from ONE manufacturer. A mount for every purpose . . . all constructed of heavy gauge steel—NOT castings—treated with a new and improved waterproof coating made to Navy specifications for complete protection against any weather conditions . . . in a handsome semi-gloss silver finish. Vise-type clamps accommodating masts of 3/4" to 2 1/2" . . . all hardware pre-assembled so that no time is lost in installation.

Mounts for CHIMNEYS • EAVES VENT PIPES • WALLS . . . also MAST JOINERS and EXTENDERS  
METALACE SETS THE PACE

# Metalace

CORPORATION  
Dept. 106  
2101 GRAND CONCOURSE  
NEW YORK 53, N. Y.

Model CMA  
\$4.75 list

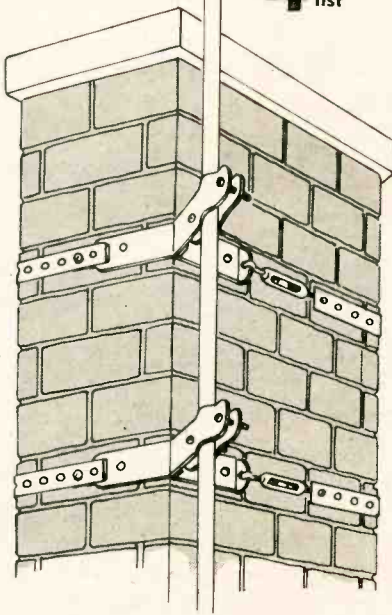

## IMMEDIATE DELIVERY

Write today for illustrated circular and discounts.

## QUOTES

"In addition to realistic pricing that will be within reach of people's pocket-books, it will take aggressive salesmanship to bring the television market to its highest potential. After all, a television console is one of the biggest purchases a family can make. People who have viewed television like it enough to adjust their budgets to buy it, but it must still be sold."—Ross D. Siragusa, president Admiral Corporation, Chicago.

"Very few appliance dealers today have an adequate sales force to meet the challenge of competitive selling conditions. While manufacturers must continue extensive advertising programs aimed at bringing prospects into stores, the best advertising in the world fails if it leads the prospect to an uninformed or prejudiced dealer or retail salesman."—Edward R. Taylor, manager of market development, Hotpoint, Inc., Chicago.

"Philco, as a manufacturer, will continue to give servicemen all possible help in the form of technical training, information and field engineering but will not usurp the servicemen's job."—James M. Skinner, Jr., vice-president, service and parts, Philco Corporation. (In address at meeting of the Federation of Radio Servicemen's Association of Pennsylvania.)

## News of Jobbers, Reps.

R. M. Karet Associates, Inc., 510 No. Dearborn St., Chicago, have been appointed as exclusive national sales representatives for the new Hi-Lo indoor TV antenna made by Ferris Television Labs. of Chicago. The new aerial features 12 channel coverage without requiring adjustment of any kind except orientation. List price is \$9.95.

Appointment of two new sales reps. to assist Arvin district managers has been announced by Gordon T. Ritter, director of sales for Arvin division of Noblitt-Sparks Industries, Inc. Palmer McMahon will work with Weldon Payne, Arvin district manager in Illinois, Wisconsin and northern Indiana. Warren Pringle will work with Robert Smith, district manager in New York, Pennsylvania, Virginia, New Jersey, Delaware, Maryland and the District of Columbia.

New Graybar appointments: R. L. Coward has become manager of the Graybar-Bristol branch in the Southern district; W. R. Windfield is district operating manager at Graybar Seattle, and J. R. Ernest has been appointed district operating manager at Kansas City.

The Radiart Corporation, Cleveland, Ohio, announces the following appointments: Marvin H. Kirkeby for central Northwest territory; the W. Bert Knight Co., for southern California, and the E. L. Berman Company, for northern California.

E. C. Bonia general sales manager of Bendix Radio and Television has announced the appointment of Jack C. Gardner as special sales representative. "Mr Gardner's long experience in the radio and appliance industry qualifies him admirably for this position," Mr Bonia commented. "He will be contacting district merchandisers and key dealers in arranging sales meetings and inaugurating sales training programs," he concluded.

Camfield Manufacturing Company of Grand Haven, Michigan, has announced the appointment of the C. L. Cole Company of Lexington, Mass., as factory representatives in the Boston territory, which includes the states of Connecticut, Maine, Massachusetts, New Hampshire, Rhode Island and Vermont.

J. J. Golumbo, president of J. J. Golumbo & Co., exclusive distributors for Andrea "Sharp-Focus" television in the Boston area, noted at a trade showing of three new Andrea television models at the Andrea showrooms in Long Island City, that there are now 40,000 television receivers in the metropolitan area of Boston, and he predicted that by the beginning of 1950, there would be close to 400,000 television sets in the same area. He based this prediction on the fact that the televising of programs throughout the country, on a coast-to-coast basis is making such wonderful progress that many new shows are now available to Bostonians.

Frank M. Brown Company, 12-16 Free Street, Portland, Maine, has been appointed distributors for Arvin Radios and electrical appliances in the state of Maine and in Coas, Carroll, Belknap and Grafton Counties, New Hampshire.

## Everybody's Talking About . . . THE NEW RMS TELEVISION ANTENNA LINE

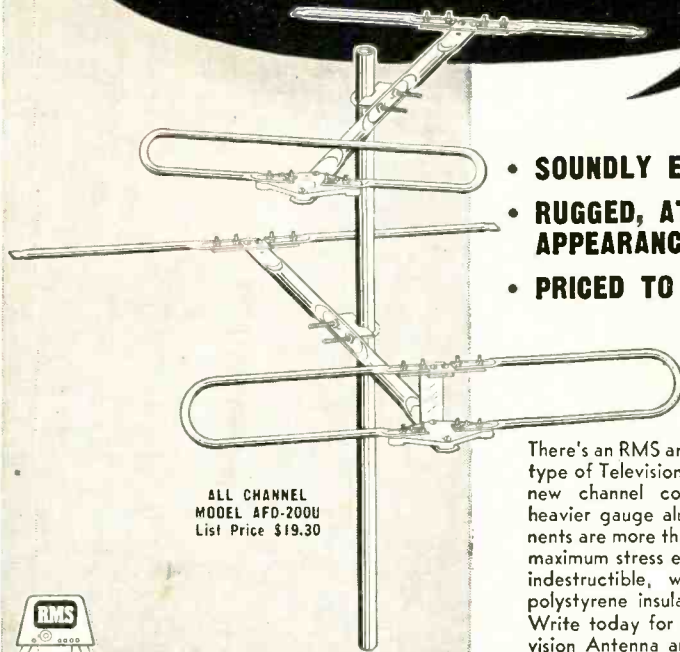

ALL CHANNEL  
MODEL AFD-200U  
List Price \$19.30



- SOUNDLY ENGINEERED
- RUGGED, ATTRACTIVE APPEARANCE
- PRICED TO SELL FAST

RMA

There's an RMS antenna for every type of Television installation . . . new channel construction and heavier gauge aluminum components are more than adequate for maximum stress encountered . . . indestructible, weather-resistant polystyrene insulators.

Write today for new RMS Television Antenna and Accessories

Catalog #215-R

RADIO MERCHANDISE SALES, INC.

550 WESTCHESTER AVENUE  
NEW YORK 55, N. Y.

## dealers prefer

# Videola

TELEVISION



Complete 12½ and 16-inch home television line

FEATURING THESE VIDEOLA ADVANTAGES:

- EXCLUSIVE PLAKRON COMPENSATOR in advanced circuit design for life-like reproduction.
- EYE-LIGHT PANEL . . . lessens eye-fatigue.
- AUTOMATIC LOCK-IN SYNCHRONIZER for pictures that snap into place.
- AUTOMATIC GAIN CONTROL . . . picture always at right level.
- INTERMODULATION SYSTEM synchronizes sound — eliminates drift.
- FUSED CIRCUITS for greater safety.
- Manufactured under RCA License.

No getting away from it . . . dealers like to carry the Videola line. Bigger dealer discounts — and how! Tie-in deals — absolutely none! And sales — well, Videola features help the dealer sell. Their low prices, advanced engineering, superior performance and beautiful cabinets are real customer "stoppers"! Write to Dept. E for the new brochure of our complete line. Distributors: Some territories still open. Wire or write today.

# Video Corporation of America

229 WEST 28th STREET • NEW YORK 1, NEW YORK



# Television's Great New DISAPPEARING ACT!

The CRAFTSMEN  
**SLIDE-RULE\***  
ANTENNA

NOW YOU SEE IT . . .

With calibrated dipole arms extended, the amazing new Slide-Rule antenna gives you instant, precision tuning of all TV channels and FM. One simple operation! Works on any TV set.



ONLY  
**\$9.95**

No other antenna gives you  
**ALL THESE FEATURES**

- **INSTANT CHANNEL TUNING.** Dipole arm is calibrated with all TV channel numbers, plus entire FM band. Simply extend one metal loop to desired channel position. Other arm extends automatically. Slide-rule accuracy!
- **FOLDED DIPOLE DESIGN.** Never before on a portable antenna! Rugged, efficient folded dipole gives sharper, better performance — with 20 per cent less dipole length!
- **PERFECT RECEIVER MATCH.** Eliminates "ghosts," inter-channel interference, etc., due to mismatching. Ample lead is 300-ohm, twin-line type — correctly matches antenna and receiver!
- **FULLY RETRACTING ARMS.** Push button control silently retracts dipole into attractive walnut hammertone housing. Only 4 1/2" x 2 1/2" when closed! Felt bottom protects furniture.

NOW YOU DON'T!

What compactness! With the click of a button, antenna arms disappear smoothly, silently into a case so small it would fit in your pocket! No unsightly indoor antenna. No expensive rooftop installation.

\*Patent Pending Sold by leading distributors For information, write dept. A

**The RADIO CRAFTSMEN Inc.**  
1341 S. MICHIGAN AVE., CHICAGO 5, ILL.

FOR THAT "FRINGE" AREA

A Better Picture  
and a  
Good Profit, Too!  
with

**CHAMPION**  
Television Towers

Guyed Towers  
45', 65', 85'

Self-Supporting  
Towers  
40', 53', 67', 80'

Make Your  
Television Sales  
Stick

Use Champion  
Steel Towers

Strong  
—and Easy  
to Erect

Sold through  
Dealers and Jobbers

Write for Literature  
**Norman M. Sewell**  
Inc.

Susquehanna Ave.  
at Derstine  
LANSDALE, PA.

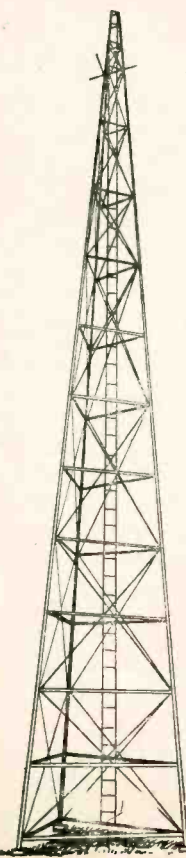

And Now . . . Introducing  
Movement with **LIGHTS!**

**KASSON** Model "712"  
**Roto-Sho**  
ELECTRIC TURNTABLES

The **ACTION** Display-Way  
To Boost Your Sales!

**M**ODEL "712" ROTO-SHO's two-way built-in electric outlet permits novel, self-contained lighting effects as well as operation of electrical devices while the turntable revolves three times a minute! (Lights turn with table.)

There's nothing like "712" to revolutionize your window trim, because motion plus correct lighting is the key to successful displays. Sturdy construction, guaranteed, carries up to 200 lbs. Table 18" in diameter. A.C. only.

Write for our complete ROTO-PRODUCTS catalog!



**GENERAL DIE AND STAMPING CO.**  
Dept. TV, 262 Mott St., New York 12, N. Y.

## Tele-tone Award



S. W. Gross, president of Tele-tone Radio Corp., New York City, presents a silver plaque and congratulatory handclasp to M. Beckwith, head of the company's New England distributing organization, for achieving the highest sales record in 1948.

## Admiral Names Walt

Appointment of John B. Walt as assistant advertising manager of Admiral Corp. has been announced by Seymour Mintz, director of advertising.

## Arvin Plans New Products

The annual report of Noblitt-Sparks Industries, Inc., indicates that the company will manufacture and market an Arvin direct-view television set in table and console types as well as introduce an automatic "pop-up" toaster and a new electric space heater with exclusive safety devices. The report states that 1948 was the greatest sales year in company history with a gross of \$35,-447,580. Q. G. Noblitt, chairman, and Glenn W. Thompson, president, announced that the company's post-war expansion projects were completed during 1948.

## Alliance Sales Rep



George Petitt, above, has been appointed as a sales representative for the jobber division of the Alliance Mfg. Co., Alliance, O., it was announced by John Bentia, Alliance sales manager.

# THE TWO-IN-ONE REPLACEMENT...

# AEROVOX

## DUAL

## DANDEES



- Where two capacitors have to be squeezed into the space of one, these Aerovox Dual Dandees do the trick. Type PRS-A has two electrolytic sections concentrically wound, with insulated positive leads at one end and common negative at other. Type PRS-B has separate-section dual units with separate positive and separate negative leads for each section. Colored polarity-indicating leads. Popular voltages, capacitances, combinations.

- These and other servicing aids are listed in latest Aerovox catalog. Ask for your copy — or write us.



**FOR RADIO-ELECTRONIC AND  
INDUSTRIAL APPLICATIONS**

AEROVOX CORP., NEW BEDFORD, MASS., U.S.A.  
Export: 13 E. 40th St., New York 16, N.Y. • Cable: 'ARLAB'  
In Canada: AEROVOX CANADA LTD., Hamilton, Ont.

RADIO & TELEVISION RETAILING • April, 1949

## Active Polaroid Campaign Continues to Up Sales

The Polaroid Television Filter continues to be a sales bonanza for leading dealers everywhere, according to officials of the Pioneer Scientific Corporation, in announcing that more than 150,000 television set owners are possessors of Polaroid Filters purchased at retail prices ranging from \$6.50 for 7-inch tube to \$25 for 20-inch tube.

Remarkable sales results were obtained by an intensive advertising and merchandising set-up planned by Pioneer Scientific Corporation with Cayton, Inc., its advertising agency. Since every TV set owner was a prospect, the advertising program was concentrated in television, and a sales maker campaign tied in the cooperation of dealers. A sales maker kit was sent to each dealer with his first order of filters. It contained a sample of a consumer folder, suggested sales letter and order card to be sent to all purchasers of television sets, newspaper mat service, illustration of the counter display, sales manual and a gift order for each sales person—a pair of Polaroid sun glasses and a picture. Realizing the importance of making the entire manufacturer, distributor, and dealer program a single, coordinated entity, these tie-in advertisements and promotional pieces were designed along similar lines.

In city after city, spot film commercials, backbone of the entire advertising program, were carefully selected. In New York, in addition to a full spot schedule, Polaroid sponsored the popular Dennis James wrestling matches telecast on WABD.



Polaroid sponsored a weekly television magic show. Shown is Andre Baruch posing as an Indian fakir demonstrating the firm's product to viewers.

Large space ads were taken in all leading newspapers of each city where the show is telecast, in order to assure as large an audience as possible for the telecast. And unusually attractive, eye-catching window streamers were sent to all distributors for placement in dealers' windows.

Deals were set up permitting the mention of merchants' names in return for the purchase of a certain number of the filters.

Another TV event sponsored by the firm was the sensational Howdy Doody Show. A tie-in premium offer was

(Continued on page 118)

# FOUND!

the "MISSING LINK" to  
**GOOD TV ANTENNA  
INSTALLATIONS**

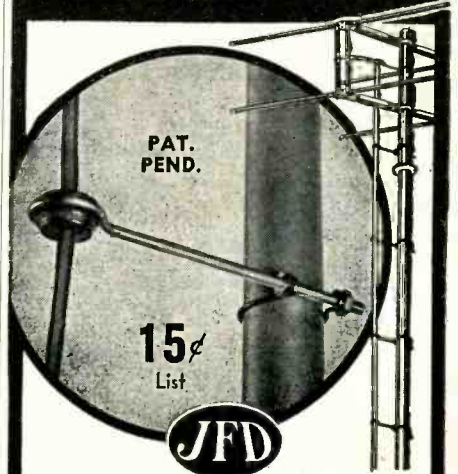

## MAST CLAMP LEAD-IN SUPPORTS

Made with **POLYETHYLENE**  
(the ultra-low loss insulation material)

Now you can make any old or new TV installation last longer, look neater, perform better with the unique JFD Mast-Clamp Lead-In Supports. These new Screw Eye Insulators are JFD-engineered to anchor lead-ins firmly in place and assure better TV/FM reception.

- TL100-350**  
1" Clamp with 3/2" Screw Eye for Twin Lead. Standard Ctn. 100 **15¢ List**
- RG100-350**  
1" Clamp with 3/2" Screw Eye for Coaxial Cable. Standard Ctn. 100 **15¢ List**
- DTL100-350**  
1" Clamp with 3/2" Screw Eye for two Twin Leads. Standard Ctn. 50 **35¢ List**
- DBR18TL3**  
3/2" Screw Eye with wood-screw thread, for two Twin Leads. Standard Ctn. 50 **28¢ List**

Mast Clamps are made in all sizes for all applications, individually designed to fit masts from 1/2" to 2" O.D. Screw Eyes range from 3/2" to 12" in length.

Visit JFD Booth 117 at Chicago Radio Parts Show in May

**JFD MANUFACTURING CO. Inc.**

6115 16th Avenue  
Brooklyn 4, New York

WRITE TODAY  
for Valuable 4-page Bulletin #DBR

© Copyright 1949 by JFD Mfg. Co. Inc.

FIRST In Television Antennas and Accessories

All rights reserved. No part of above work may be reproduced in any form except by written permission of the manufacturer.

Eliminate the Variables  
in  
Television Installation  
with the



**FIELD STRENGTH METER**

Do not depend on pictures—  
Use absolute measurements—  
Direct Meter Readings



Improves Installation!!  
Saves 1/2 the Work!!

Has numerous features and advantages, including—(1) Measures actual picture signal strength . . . (2) Permits actual picture signal measurements without the use of a complete television set . . . (3) Antenna orientation can be done exactly . . . (4) Measures losses or gain of various antenna and lead-in combinations . . . (5) Useful for checking receiver re-radiation (local oscillator) . . . (6) 12 CHANNEL SELECTOR . . . (7) Amplitudes of interfering signals can be checked . . . (8) Weighs only 5 lbs. . . (9) Individually calibrated . . . (10) Housed in attractive metal carrying case . . . (11) Initial cost of this unit is covered after only 3 or 4 installations . . . (12) Operates on 110V, 60 Cycles, A.C. Model FSM-1, complete with tubes . . . \$99.50

Transvision offers a complete line:

- Television Kits and Cabinets
- Field Strength Meter
- Sweep Signal Generator
- All-Channel TV Booster
- Remote Control Units
- Tuners • Lenses • Antennas
- Accessories and Parts

All prices fair traded . . . 5% higher west of the Mississippi River.  
See Your Local Transvision Outlet, or  
Mail this coupon today to:—

**TRANSVISION, INC.**  
NEW ROCHELLE, N. Y.

Please ship THROUGH YOUR NEAREST LOCAL OUTLET:— RR 4

( ) Field Strength Meters  
I am enclosing 10% DEPOSIT in the amount of \$ . . . , balance C.O.D.  
( ) Send details of Dealer Plan.

Name . . . . .  
(please print)

Address . . . . .

City & State . . . . .

**Polaroid Campaign**

(Continued from page 117)

made possible by the use of a Polaroid Magic Picture. The Howdy Doody Magic Picture promotion was extensively merchandised.

Another part of the merchandising promotion was the five color silk-screen display 18 x 28 inches, dramatizing Howdy Doody and the premium offer.

Several weeks ago, Pioneer premiered the "Pioneer-Polaroid Magic Show" telecast every Wednesday evening from 7:45 to 8:00 P. M., immediately preceding the Arthur Godfrey Show over the entire CBS Television eastern network and over many other stations throughout the country by kinescope recording.

Cayton, Inc., is now working out a novel demonstration unit for dealers, allowing them to demonstrate the Polaroid Television Filter easily and effectively on a television set. The unit fits over the front of a television set and the Polaroid Television Filter slides across the television screen.

A new size Polaroid Television Filter to fit all 16" television sets is now available to dealers everywhere, together with all other sizes, it has been announced by Hunter Delatour, advertising manager of Pioneer Scientific Corporation.

Retail prices are as follows: For all sets with 7" tube: \$6.50. 10" tube: \$10. 12" tube: \$12.50. 15" tube: \$16. 16" tube: \$17.50. 20" tube: \$25.

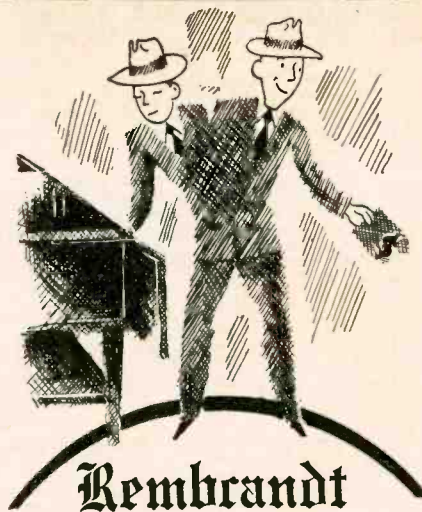

**Rembrandt**

TELEVISION

MAKES **BUYERS** OUT OF **BROWSERS!**

Rembrandt proudly steps forward with Model 1606 combination Television & FM Radio in an authentic console reproduction of an early Flemish Cabinet. Your customers will delight to its 72" crystal-clear picture, it's rich, tone-pure FM sound reception, it's "down-to-earth" prices.

Order Rembrandt today and turn every browser into a buyer!

Model 1606—12" picture tube, FM Radio, mounted safety glass (easily removable for cleaning,) Remington Automatic Picture Stabilizer, Advanced Automatic Gain Control for sound and video. Available in Mahogany and Walnut, \$495. Also Maple, Blond Mahogany, Knotty Pine or Chinese Hand-Painted Finishes slightly higher. Also available in Model 1606-15 (similar) with 15" tube.

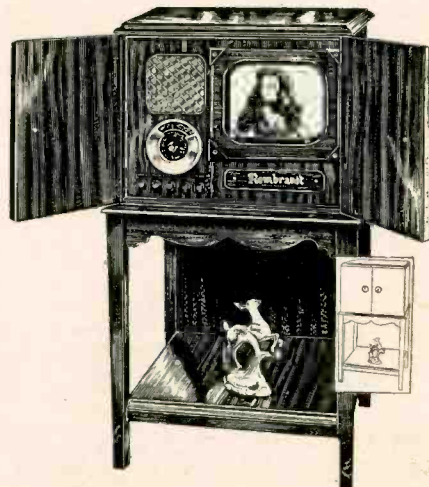

**REMINGTON**

Radio Corporation

White Plains, New York

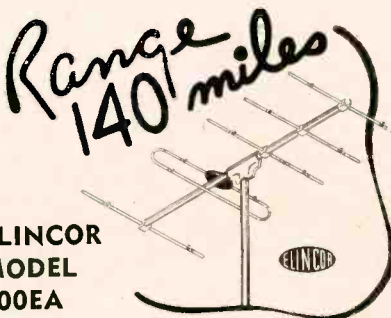

**ELINCOR MODEL 300EA**

A 5 element beam adjustable from channels 2 to 6. 8 1/2 ft. over all.

List Price \$41.50

**ELINCOR MODEL 520TVA**

for channels 7-13, non-adjustable.

List Price \$14.75

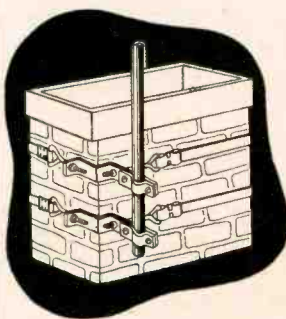

**ELINCOR MODEL 50**

List Price \$4.35

Chimney mount, sturdily constructed of 1 1/2" steel, cadmium plated with 24 ft. of galvanized strapping.

Send for Free "49" catalog.



**ELECTRONIC INDICATOR CORP.**

53 Wyckoff St., Brooklyn, N. Y.



# A TRYLON TOWER FOR EVERY ANTENNA



- Complete Towers at One Price—No Extras
- Hot-Dipped Galvanizing
- Prefabricated Guys with TRYLON Pres-Tite Sleeves
- PALNUTS for Every Bolt
- Easy-to-Climb Ladder

Whether it's a single dipole or a stacked array, TRYLON has the towers and the proper fittings adaptable to the antenna. They're inexpensive and easy to install, and they are especially important for dependable TV reception in "fringe" areas where antenna elevation is a "must." A ladder on one face of every TRYLON Tower makes easy climbing for antenna orientation.

Buy Direct from the Manufacturer. Write for prices and complete details. Trylon Tower and Antenna Division, Wind Turbine Co., West Chester, Pa.

## TRYLON LADDER TOWERS

Guyed Towers—F-M and Television  
Antenna Supports—Amateur Radio  
Towers of All Types

### Statement on Proposed IT&T-Farnsworth Merger

About April 20, 1949, if the plan is approved by Farnsworth stockholders and the agreement with International Telephone and Telegraph is consummated according to its terms, all of the business and properties, manufacturing facilities, inventories, patents, etc. of Farnsworth Television & Radio Corporation will be transferred to a new company which will become a wholly-owned subsidiary of International. "Upon the completion of this merger, the full force of International's resources will be brought behind the manufacture of Farnsworth and Capehart products," says E. A. Nicholas, Farnsworth president, who issued the following statement:

"In the home entertainment field, i.e., the radio, television and record-player fields, there are no more distinguished names than Capehart and Farnsworth.

"Steps will be taken not only to preserve the commercial values developed by these products, but also to assure distributors, dealers and the public that henceforth Capehart and Farnsworth instruments will be backed by a manufacturing organization strong enough to meet the problems of expanding delivery at competitive prices with fully adequate advertising support.

"By linking itself to the Capehart and Farnsworth products, International with all its resources becomes associated with a top-ranking manufacturing outlet and distributor-dealer organization, thus providing a much larger and more effective channel to consumer markets.

"International Telephone and Telegraph is a corporation with great resources and a world-wide organization in the field of telecommunications, with 31 manufacturing plants in 22 countries, several cable and radio operating companies, electronic research laboratories in the United States, England and France, a number of telephone operating companies in other countries, and a manufacturing subsidiary in the United States, Federal Telephone and Radio Corporation.

"It is of particular interest that International has for many years been in the forefront of television equipment. Through a research associate, Federal Telecommunications Laboratories, it was one of the earliest to enter the field of television research, not only in black and white but also in color television.

"It may be stated that in all phases of radio and television manufacture, excepting the home products field, International has long played an important part.

"International has already advanced funds which are being used to start Capehart and Farnsworth products back on the road to full production.

"Distributors and dealers will be assured of the strongest possible backing in quality, price, and retail sales promotion. No changes are contemplated in the present manufacture-distributor-dealer relationship."

# TRANSVISION

## "Flip Up"

### TV ANTENNA

... the revolutionary PRE-ASSEMBLED, PRE-WIRED TV ANTENNA that gives Superior Performance on ALL CHANNELS—yet COSTS YOU ONLY 1/2 the price of equivalent antennas!

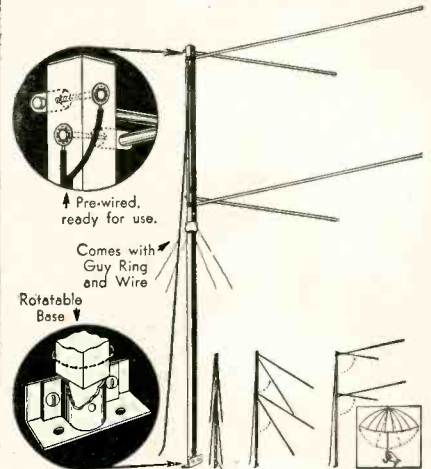

- PRE-ASSEMBLED, ready for use, just "flip-up" (like an umbrella) and install.
- PRE-WIRED — just connect your lead-in to the two terminals.
- RECEIVES ALL CHANNELS
- ALL-DIRECTIONAL; can be oriented for the weakest station in an area with assurance that all other channels will be brought in equally well.
- Extremely Sensitive. Unusual high gain on upper channels. Ideal for fringe areas.
- PRICE: \$9.95 LIST

Completely assembled with rotatable base, 7-ft. mast, guy ring and guy wire. Additional 7-ft. masts, to build antenna up to 19 ft., at small extra cost.

All prices fair traded . . . 5% higher west of the Mississippi River.

See Your local Transvision Outlet, or

Mail this coupon today to:—

## TRANSVISION, INC.

NEW ROCHELLE, N. Y.

Please ship THROUGH YOUR NEAREST LOCAL OUTLET:— RR 4

( ) "Flip-Up" Antennas

I am enclosing 10% DEPOSIT in the amount of \$ . . . . ., balance C.O.D.

( ) Send details of Dealer Plan.

Name . . . . .  
(please print)

Address . . . . .

City & State . . . . .

# HOW TO SOLVE TV RECEPTION PROBLEMS

## IN LOCAL AREAS

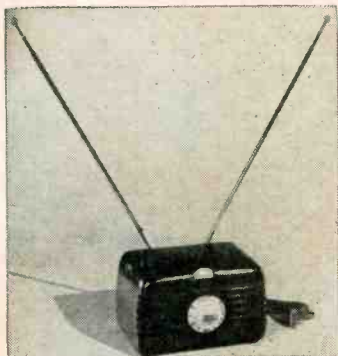

Jerrold In-Tenna is the only indoor TV antenna that will give you clear pictures on ALL TV stations in your area. It can easily be oriented to reduce noise and ghosts. The tuned pre-amplifier helps eliminate all kinds of interference from FM, TV and AM. It is easily and quickly installed in any home or apartment. The Jerrold In-Tenna will give your TV set the same performance that you could expect from a costly outdoor installation. List \$42.50.

See the Jerrold In-Tenna at your radio wholesaler or parts jobber, or write to us for information.

## IN FRINGE AREAS

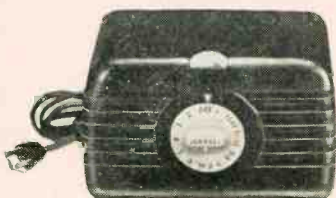

The Jerrold TV-FM Booster has a gain of 20 to 30 times over the entire 6 megacycle bandwidth of all TV channels—plus the FM band. Because of its high gain, Jerrold TV-FM Booster pulls weak stations out of the "mud" to give you the clearest possible pictures. Sight and sound tune together. There is no regeneration whatsoever. All kinds of interference, as well as ghosts, are either greatly reduced or completely eliminated.

See the Jerrold TV-FM Booster at your radio wholesaler or parts jobber. Or write to us for information. List, \$37.50.

**JERROLD ELECTRONICS CORP.**  
121 N. BROAD ST. PHILA. 7, PA.

## Emerson Appointees



Emerson Radio & Phonograph Corp., has named Stanley M. Abrams, left, new sales manager of the television division, and Harold E. Karlsruher, right, as head of the home radio division.

## GE Issues "Techni-Talk"

The Tube Division of the General Electric Company, Electronics Park, Syracuse, N. Y., has announced it will issue copies of "Techni-Talk" bi-monthly. Available through GE and Ken-Rad distributors, it is designed to keep servicemen and dealers abreast of the latest developments in radio and television, and to assist them with technical problems encountered in the field. Techni-Talk is distributed by mail and comes to the dealer through his distributors, without cost.

## The RAMSEY TV TOWER



80¢ PER FOOT  
(Unassembled)

Assemble with only a screwdriver.

Join 10 foot sections to make towers up to 70 feet.

Weighs only 15 pounds per 10 foot section.

All Hardware and connecting links furnished.

Non-metallic construction won't attract lightning nor cause twinex leadin loss.

Easily erected by two men.

Can be climbed.

See your parts jobber or write

**RAMSEY TOWER CO.**  
P.O. BOX 45, RAMSEY, ILLINOIS

## the new Streamlined MODEL 322A TUBE TESTER



Priced at only **\$37.95**

A tube tester downright easy to operate. This is one of the lowest priced tube testers anywhere, yet it permits accurate checking of the widest variety of old or new tubes—equipped with the new sub-miniature tube socket.

### CHECK THESE FEATURES

- This tube tester has provisions for checking individual sections of multi-purpose tubes as well as miniature and sub-miniature receiving tubes.
  - Closer tolerances are easily obtained due to special Atenco A.C. meter and extremely low test circuit voltage drop.
  - Convenient jack is provided for head-phone noise test to check noisy swinging, or high resistance internal tube connections.
  - Neon lamp for rapid short and leakage tests between elements.
  - Compact, sturdy construction.
  - Operates on 100-130 volt, 50/60 cycle A.C. power supply.
- Open-face in new hammertone grey finish steel cabinet with sloping panel. Size 5 1/4" x 12 3/16" x 8". Weight: 11 lbs. Buy it from your local jobber. Send for Bulletin No. 5RT

## RADIO CITY PRODUCTS CO., INC.

152 West 25th St. New York 1, N. Y.

## SHOOTS TROUBLE

**FASTER!** Makes more money for you on job or at service bench!



PRICE  
**\$9.95**

at distributor or postpaid, direct. Sorry no COD's. Ohioans add 3% State Sales Tax.

## Signalette

### MULTI-FREQUENCY GENERATOR

In radio service work, time means money. Locate trouble faster, handle a much greater volume of work with the SIGNALETTE. As a trouble shooting tool, SIGNALETTE has no equal. Merely plug in any 110V. AC-DC line, start at speaker end of circuit and trace back, stage by stage, listening in ser's speaker. Generates RF, IF and AUDIO Frequencies, 2500 cycles to 20 Megacycles. Also used for checks on Sensitivity, Gain, Peaking, Shielding, Tube testing. Wt. 13 oz. Fits pocket or tool kit. See at your dist. or order direct.

**Clippard** Instrument Laboratory, Inc.

Dept. R, 1125 Bank St., Cincinnati 14  
Qualified Jobbers write, wire for details.

# Portable TRI-TUBE



## Antenna MASTS

TELEVISION  
FM • AMATEUR  
COMMERCIAL

LOW  
COST  
•  
LIGHT  
•  
QUICK  
•  
EASY

Most section is triangular in construction using 1" ID steel tubing with proper bracing, all electric welding. Lower unit is 20 ft. long hinged on frame with locking device. Levelling device compensates for position of vehicle on any test location. Upper unit is a smaller triangle and telescopes into lower unit on rollers, which allow smoother operation. Cable and drum provided with pin assembly for safety and locking into any height. Antenna mast can be set up by two men in a few moments... NO GUYS - NO WRENCHES - NO BOLTS. All bolts have 'T' handles. Demountable by removing two bolts in four minutes. Aluminum painted ready to mount.

- 250 BASIC UNIT COMPLETE 50 ft., 10 ft. pole
- 251 SAME AS 250-ORIENTATION AT ANY HEIGHT
- 252 SAME AS 251, WITH ANTENNA HEIGHT 70 FEET

A. A. PETERS  
**TRI-TUBE MASTS**  
231 N. 7th Allentown Pa.

SHIPPED F. O. B.  
ALLENTOWN, PA.

\$295  
and up



## LIFE-SIZE TELEVISION is here!



CORTLEY MODEL #720

### UNLIMITED SALES OPPORTUNITIES

Your sales possibilities with the CORTLEY PROJECTION TELEVISION RECEIVER are absolutely unlimited. Bars, Restaurants, Schools, Clubs, Churches, Hospitals, Resorts—these are but a FEW prospects! They have been clamoring for television that can be seen by several hundred people at one sitting—and now you can supply them. Get in on this brand new, easy-to-sell market. Be the first in your community to fill the enormous need. Send for full information and price today! A limited number of Cortley Distributorships are still available. Write for particulars now.

### CORTLEY TELEVISION CORP.

Dept. E 130 West 24th Street  
New York 11, N. Y. AL-5-3680

## RCA Victor Officials



Allen B. Mills, above, whose appointment as general sales manager of the RCA Victor Home Instrument Department was announced by Henry G. Baker, general manager. H. M. Rundle, below, has been appointed merchandise manager of the RCA Victor Home Instrument Department. Mr. Baker also announced.



## New Du Mont List Prices

Allen B. Du Mont Laboratories, Inc., New York City, has announced new list prices on nine models of its television receiver line, Victor E. Olson, sales manager of the Receiver Division stated. The new prices are: Chatham (mahogany) \$425; Chatham (Blonde) \$435; Savoy (mahogany) \$695; Savoy (Blonde) \$715; Winthrop \$695; Stratford (Mahogany) \$594; Stratford (Blonde) \$605; Colony \$945; Westbury \$745.

## Alliance Announces Two New Phonomotor Units

Two new record player phonomotor units especially designed for use with the slower speed LP microgroove records were announced by R. F. Doyle, president and treasurer of the Alliance Manufacturing Company, Alliance, Ohio. One model combines both speeds—33½ and 45 RPM. This is a dual-speed single-play record player assembly primarily intended as a single player for those who will want speeds combined in a single unit. However, the mechanism consisting of motor and turntable can also be adapted to changers.

In addition to the new dual-speed unit, Alliance also announces a new single-play 45 RPM record player assembly designed expressly for the newer records which will play at this speed.

Everybody agrees  
**ATR VIBRATORS**  
are TOPS!

# ATR

## AUTO RADIO VIBRATORS

have Ceramic Stack Spacers

Visit ATR booth  
82 Radio Parts  
Show, May 16 to  
20 - Chicago



### A COMPLETE LINE OF VIBRATORS...

Designed for Use in Standard Vibrator-Operated Auto Radio Receivers. Built with Precision Construction, featuring Ceramic Stack Spacers for Longer Lasting Life.

Backed by more than 17 years of experience in Vibrator Design, Development, and Manufacturing.

ATR PIONEERED IN THE VIBRATOR FIELD.

NEW  
VIBRATOR GUIDE  
FREE



## "A" BATTERY ELIMINATORS

for DEMONSTRATING AND TESTING AUTO RADIOS

New Models... Designed for testing D. C. Electrical Apparatus on Regular A. C. Lines. Equipped with Full-Wave Dry Disc Type Rectifier, Assuring Noiseless, Interference-Free Operation and Extreme Long Life and Reliability.

NEW MODELS ✓ NEW DESIGNS  
NEW LITERATURE ✓  
ATR "A" Battery Eliminator, DC-AC Inverters, Auto Radio Vibrators

See your jobber or write factory

AMERICAN TELEVISION & RADIO CO.

Quality Products Since 1931

SAINT PAUL 1, MINNESOTA-U. S. A.

SELF-SUPPORTING

# Easy-Up

TOWER FOR TV ANTENNA

60 ft.

50'

40'

30'

20'

10'

0'

*Just tip it up!*

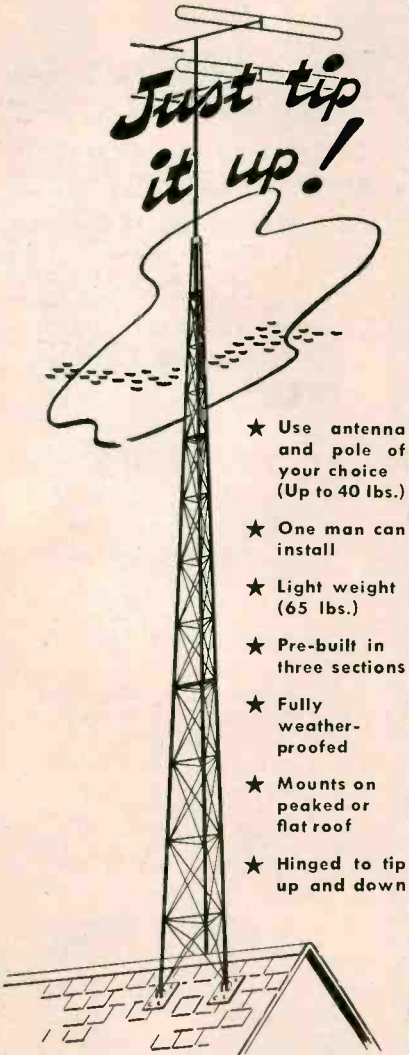

- ★ Use antenna and pole of your choice (Up to 40 lbs.)
- ★ One man can install
- ★ Light weight (65 lbs.)
- ★ Pre-built in three sections
- ★ Fully weather-proofed
- ★ Mounts on peaked or flat roof
- ★ Hinged to tip up and down

**NOW . . . SUPPLIED WITH EXTENSIONS**  
 Whatever height you need for your TV antenna in your area—it's a cinch to put it up there with EASY-UP TOWER—Basic Model consists of three prefabricated all steel sections. Additional 10 ft. extensions can be added for antenna heights up to 100 ft. above roof top (up to 60 ft. requires only 3 guys.) Sections are quickly joined together at site of installation, and tower simply tipped up on its hinged feet. Investigate!

Sold Through Jobbers Only

Write for full details

**Easy-Up Tower Co.**

3800 Kinzie Ave.  
 Racine, Wis.

## Universal Campaign



B. C. Neece, left, vice-president and general sales manager, Landers, Frary & Clark, New Britain, Conn., and S. G. Fisher, sales manager of traffic appliances, make a last minute check on the new Universal Coffeematic, with the Flavor Selector, before starting a tour of cross-country meetings to bring the new appliance to the attention of the trade.

## Tung-Sol Expansion

Due to increased activities in the Chicago area, Tung-Sol Lamp Works, Inc., have found it necessary to materially expand their facilities. They are presently in their new location, 351 East Grand Ave., Chicago 11.

## Gibson Dealer Aids

The Gibson Refrigerator Co., Greenville, Mich., is pushing a new sales promotion hand-kit package, geared to present day needs of facts about the company's products, according to Gregory V. Drumm, manager of advertising and sales promotion. The kit contains a reprint of the full color page ad appearing in current consumer national magazines. The kit also contains proofs of retailers' newspaper ads. The key-stone promotional piece in the kit is a tabloid broadside showing Gibson ranges, refrigerators and freezers. To promote store traffic, the broadside features an offer of a matched set of measuring spoons. Prospects are asked to fill out a card showing age of present appliances to enable dealer to qualify customers. A schedule sheet is provided in each kit to insure a definite follow-up of each dealer's advertising and promotional activity.

## Opto-Vision Jobbers

Television Filter Co. (formerly Television Service Co.), sole U.S. representatives for "Opto-Vision", have appointed 6 new distributors, it was announced by M. C. Rosenthal, president of the television filter organization. The newly appointed distributors, all in the New York area, include: Video Distributors, 214 Fulton Ave., Hempstead, N. Y.; Radionic Laboratories, 1010 Central Ave., Far Rockaway, N. Y.; Hudson Valley Asbestos Corp., 170 Central Ave., Albany, N. Y.; Tel-Rad Distributing Corp., 54 Clinton St., Newark, N. J.; Monmouth Radio Supply Co., 396 Shrewsbury Ave., Red Bank, N. J.; Howard E. Ellish, 46 Voorheis Ave., Nyack, N. Y.

*telrex INC.*  
**CONICAL ANTENNAS**  
*America's Outstanding Television Beam*

- ★ The ONE antenna for ALL channels (no high frequency head needed)
- ★ Maximum efficiency on ALL channels
- ★ Better than 12 DB front to back ratio on all frequencies

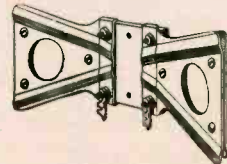

TELREX Conical Antennas provide the highest possible gain to the receiver — since the full strength of the signal (as received at

the antenna) is carried to the set with negligible loss—and with a definite reduction in the strength of ghosts or reflections.

TELREX Conical Antennas are built better. Note this center clamp which provides such a strong grip over better than 3" of each rod surface. It is both a mechanical support and electrical contact second to none. And is only one of the features which result in improved and steadier pictures — from a better antenna—a TELREX antenna.

## The 4X-TV

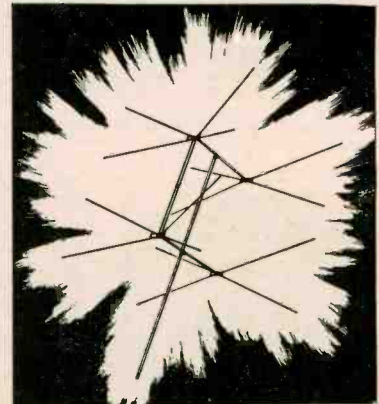

- Hi-Gain Stacked Conical "V" Beam—Channels 2 to 13
- Broad Band—Full Audio and Video Band Pass
- Low Inception Angle, Minimum Reflections
- Maximum Signal to Noise
- Better than 12 DB Front to Back Ratio All Frequencies
- 150 Ohm Non-Varying Center Impedance
- Use 72, 150 or 300 Ohm Transmission Lines
- Universal Mounting Clamp

Telrex Conical Antennas are available in a variety of models to meet any need. © 1949 Telrex, Inc.

At your distributor or write

**TELREX, INC.**  
 ASBURY PARK 2, NEW JERSEY

## Advertisers' Index—April 1949

Admiral Corp. ....	24, 25	Nicholas Equipment Co. ....	16
Aerovox Corp. ....	117	Noblitt-Sparks Industries, Inc. ....	28, 29
Alliance Mfg. Co. ....	80	North American Philips Co., Inc. ....	41, 42, 43
American Phenolic Corp. ....	112	Pentron Corp. ....	96, 97
American Television & Radio Co. ....	121	Peters, A. A. ....	121
Anchor Radio Corp. ....	106	Philco Corp. ....	5
Ansley Radio & Television, Inc. ....	62	Philmore Mfg. Co., Inc. ....	92
Bendix Radio Div. of Bendix Aviation ....	27	Philson Mfg. Co., Inc. ....	110
Bond Equipment Co. ....	80	Phoenix Electronics, Inc. ....	110
Brunswick Television Div., Radio & Television, Inc. ....	59	Pilot Radio Corp. ....	61
Celomat Corp. ....	33	Pioneer Scientific Corp. ....	6
Chicago Tribune ....	2	Premax Products div., Chisholm-Ryder Co., Inc. ....	112
Clarostat Mfg. Co., Inc. ....	114	Presto Recording Corp. ....	83
Clippard Instrument Laboratory, Inc. ....	120	Radiart Corp. ....	95
Columbia Records, Inc. ....	74, 75	Radio City Products Co., Inc. ....	120
Commercial Credit Co. ....	14	Radio Corp. of America 17-20, 31, 35, 79, Cover 4	
Cornell-Dubilier Electric Corp. ....	23	Radio Craftsmen, Inc. ....	116
Cortley Television Corp. ....	121	Radio Merchandise Sales, Inc. ....	115
Cournand & Co., E. L. ....	30	Ramsey Tower Co. ....	120
DeWald Radio Mfg. Corp. ....	113	Rauland Corp. ....	108
DuMont Laboratories, Inc., Allen B. ....	69	Remington Radio Corp. ....	118
Easy-Up Tower Co. ....	122	Rider, John F. ....	99
Electric Auto-Lite Co. ....	123	S/C Laboratories, Inc. ....	109
Electronic Indicator Corp. ....	118	Scott Radio Laboratories, Inc. ....	49
Electro-Voice, Inc. ....	104	Sewell, Inc., Norman M. ....	116
Emerson Radio & Phonograph Corp. ....	9, 54	Simpson Electric Co. ....	93
Fada Radio & Electric Co., Inc. ....	12, 13, 46, 47	Sonotone Corp. ....	82
Fisher Radio Corp. ....	64	South River Metal Products Co., Inc. ....	113
General Die & Stamping Co. ....	116	Sparks-Withington Co. ....	22
General Electric Co. ....	7, 10, 11, 81	Stewart-Warner Corp. ....	52, 53
General Industries Co. ....	72	Stromberg-Carlson Co. ....	36
Graybar Electric Co., Inc. ....	84	Sylvania Electric Products, Inc. ....	101
Hickok Electrical Instrument Co. ....	106	Technical Appliance Corp. ....	102
Hytron Radio & Electronics Corp. ....	34	Tele-King Television Corp. ....	32
Industrial Television, Inc. ....	107	Tele-tone Radio Corp. ....	15
International Television Corp. ....	56, 57	Television Filter Co. ....	109
Jensen Mfg. Co. ....	103	Telrex, Inc. ....	122
Jerrold Electronics Corp. ....	120	Trad Television Corp. ....	111
J.F.D. Mfg. Co., Inc. ....	117	Transvision, Inc. ....	118, 119
Kellogg Switchboard & Supply Co. ....	8	Tricraft Products Co. ....	124
Landers, Frary & Clark ....	86, 87	T-V Products Co. ....	124
LaPointe-Plascomold Corp. ....	105	Video Corp. of America ....	115
Mallory & Co., Inc., P. R. ....	Cover 2	Webster-Chicago Corp. ....	26
Metalace Corp. ....	114	Wilcox-Gay Corp. ....	3
Minnesota Mining & Mfg. Co. ....	21	Wind Turbine Co. ....	119
Modern-Aire Mfg. Corp. ....	112	Zenith Radio Corp. ....	4
Motorola, Inc. ....	Cover 3	Zetka Television Tubes, Inc. ....	108

While every precaution is taken to insure accuracy, we cannot guarantee against the possibility of an occasional change or omission in the preparation of this index.

...Help end  
spark plug  
**INTERFERENCE**



Spark Plugs are miniature broadcasting stations, send signals that interfere with radio reception, distort television. The New Auto-Lite "Resistor" Spark Plug reduces this interference.\*

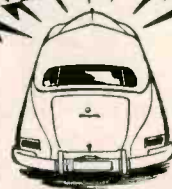

Recommend **NEW**  
**AUTO-LITE**  
*Resistor*  
**SPARK PLUG**

### Here's How It Works to End Interference

The "Resistor" acts to dampen the spark plug radio signal to an acceptable level\* while still delivering the full high voltage discharge required to ignite the fuel.



Auto-Lite Ignition Engineers, working with leading automotive manufacturers, have developed the new Auto-Lite "Resistor" Spark Plug with this built-in resistor that reduces spark plug interference.\* Remember, the "Resistor" also helps deliver smoother idling, improved economy, longer electrode life. Dealers are being supplied as rapidly as possible. Write for Booklet M-1186 for full information.

THE ELECTRIC AUTO-LITE COMPANY  
Toronto, Ontario Toledo 1, Ohio

\*Under 35mv/m from 540 k.c. to 150 m.c. at 50 ft.

Tune In "Suspense," Thursdays, 9:00 P. M., E. T., CBS

## Catalogs, Manuals and Sales Aids

**Phoenix Speed-Mounts.** A ten-page catalog containing photos, diagrams, descriptions and prices of the Phoenix line of television antenna mounts and accessories, including standoffs, guy wires, turnbuckles, etc., is available on request from Phoenix Electronics, Inc., Lawrence, Mass.

**Katolight Generators.** Catalog sheet 11248 gives complete descriptive and engineering data for Kato switchboardless 175 KW, 3-phase AC generators. Kato Engineering Co., Mankato, Minn.

**Hytron Miniature Tubes.** The 3rd edition of the Hytron Reference Guide for miniature tubes gives all data and characteristics for 91 types, 19 of them new, in a six-page booklet. Available free of charge from Hytron Radio & Electronics Corp., 76 Lafayette St., Salem, Mass.

**Raytheon Miniature Tube Chart.** The latest Raytheon miniature tube reference folder lists over 70 receiving type miniature tubes with all pertinent characteristics, applications, diagrams, etc. Raytheon Manufacturing Co., 55 Chapel St., Newton 58, Mass.

**Walden Wrenches.** The new 52-page catalog #142 lists all types of wrenches for the automotive, radio and metal trade industries. Copiously illustrated, the booklet is complete with engineering specifications for the tools. Stevens Walden, Inc Worcester, Mass.

**Electro-Voice Mikes.** Bulletin #144 illustrated bulletin gives data and information on the new E-V wide-range microphones developed for broadcasting work. A copy is obtainable on request from Electro-Voice, Inc., Buchanan, Mich.

**House of Television.** A new 12-page catalog includes illustrations, descriptions and specifications of television filters, screens, antennas, wave traps, pads, and other accessories. The House of Television, Starrett-Lehigh Bldg., New York 1, N.Y.

**New Rider Manual.** TV Manual No. 2 takes up where Vol. 1 leaves off (June 1948) and gives complete coverage up to January 1949. In addition to sets, boosters and tuners are included. Manual will sell for \$18. John F. Rider, Publisher, Inc., 480 Canal St., New York 13, N.Y.

**Sams Manuals.** Three new manuals have been released, the 1948 Record Changer Manual (including wire and tape recorders), price \$6.75; Television Antennas, a practical guide that shows what type of antenna to select, how to install it and how to solve troubles, \$1.25; and the Photofact Television Course, based on the 16 lectures originally published serially in the Photofact folders, \$3.00. Howard W. Sams & Co., Inc., 955 N. Rural St., Indianapolis, Indiana.

**Carter Converters.** Converter Catalog #349 is a 16-page booklet giving all mechanical and electrical specifications for all Carter converters, including those

for television, recording, sound recording, projection and mobile communication. Carter Motor Co., 2644 N. Maplewood Ave., Chicago, Illinois.

**Sprague Capacitors.** Sprague Bulletin #M-249 gives complete description of the Sprague television replacement electrolytic capacitors. Sprague Products Co., North Adams, Mass.

**C-D Counter Display Unit.** The counter display unit contains 12 assorted Quietone filters, with an accompanying reference guide listing filter applications. Total retail value of the kit is \$16.10. Cornell-Dubilier Electric Corp., S. Plainfield, N. J.

**GE Service Garments.** A plan for supplying service garments to General Electric and Ken-Rad tube dealers was announced which will include shopcoats, counter coats, shirt and trouser, and battle jacket and trouser combinations. The arrangement will provide for weekly delivery of laundered garments. A service charge approximately equivalent to the normal laundering charge will be the only cost to the dealer. General Electric Co., Electronics Park, Syracuse, N.Y.

**Philco Business Helps.** Shop Repair Record tags and invoice forms have been made available with the imprint of the dealer. Price for the tags is \$11.43 per 1000 and for the invoices \$5.25 per 1000. An outdoor illuminated sign is also available, for \$7.90, and a "product strip" for existing signs is 50¢. Philco Corp., Service Division, Broad and Somerset Sts., Philadelphia 32, Penna.

## Your Antenna Mounting Problem

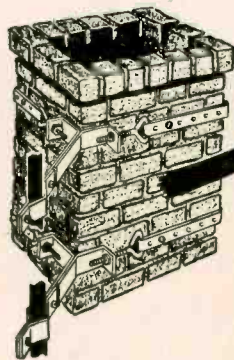

**Solved**  
WITH **CM-100**  
**CHIMNEY MOUNT**

**\$4.25**  
PAIR LIST

This antenna mounting bracket is made of 1/2" steel, heavily plated for weather resistance, and welded together for maximum strength, stability, and long-lasting durability. The CM-100 comes complete, ready to mount with all hardware and instructions. It is so simple to mount, it can be done by only one person, and requires approximately 5 minutes to install.

- Extremely Easy To Install (ONE MAN OPERATION)
- Rigid-All-Steel Construction (1/4" STEEL, WELDED)
- Two Separate Sections (DISTANCE BETWEEN SECTIONS VARIABLE - AS REQUIRED)
- Fits Any Chimney (SQUARE, ROUND, ETC.)
- Fits Any Size Mast (1/4" to 1/2")
- Weather Resistant (Heavily Plated)
- All Hardware & Instructions Included

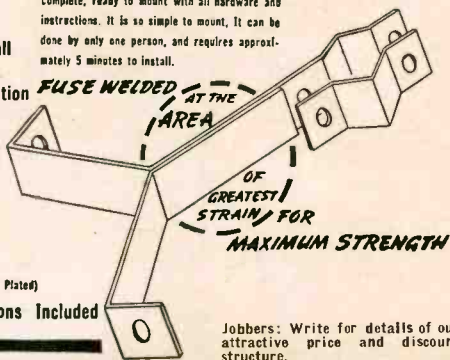

Jobbers: Write for details of our attractive price and discount structure.  
Dealers: Contact your local jobber. If he does not stock the CM 100, send us his name and address.  
**WRITE NOW. DEPT. RTR4.**

**T-V PRODUCTS CO.**  
122-10 15th AVE. COLLEGE POINT, N. Y.

## Success! IT'S HERE!



Model "600"

Patents Applied for

**TRICRAFT VIDEO ANTENNA**  
for  
**Indoor Use**

The indoor model television antenna the industry has needed!

- Appearance
- Operation Principle
- Simplicity
- Reception

Here is the new VIDEO ANTENNA you've been waiting for... new luxurious appearance which blends with any type furnishings... new design and operation, no mechanical adjustments to change stations, turn switch to channel desired, electrically tuned to station... good reception for as far as 25 miles, 1 to 1.5 standing wave ratio in each channel... easy to use, instantly ready for use... operates anywhere in the house, no landlord's permission needed... net weight only 3 3/4 lbs.

"Tricraft" antennas are available at leading jobbers. If your jobber cannot supply you, write us for nearest jobber.



**Tricraft Products Co.**

1533 North Ashland Ave., Chicago 22, Ill.

Manufacturers of complete line of Television, FM and AM antennas and accessories

# Believe It or Not! by RIPLEY



Robert  
**RIPLEY**

World-famous artist,  
traveler and storyteller —  
brings to the television  
screen his most unusual  
and exciting tales.

HIS FAMOUS  
**Believe It or Not's**  
ARE NOW WORKING  
FOR YOU!

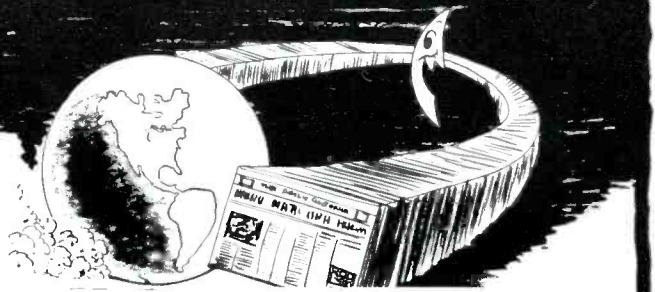

**Believe It or Not** cartoons have helped  
sell enough newspapers to reach from  
here to the moon and back every day for 20 yrs.  
**THIS TREMENDOUS SELLING POWER  
IS NOW WORKING FOR YOU...**

comedy

thrills

variety

drama

every week on NBC network

See your newspaper for time and station in your community

## Believe It or Not on TELEVISION

starring in person ROBERT RIPLEY with the most  
exciting — most startling stories in the world.

presented by

# Motorola RADIOS-TELEVISION

*Motorola Inc.*  
4545 AUGUSTA BLVD.  
CHICAGO 51  
ILLINOIS

PROMOTION  
MATERIAL  
IS READY  
FOR YOU

contact your *Motorola* distributor today



EDWIN  
JACOBSEN  
Miami YMCA  
Senior Member

CAN WALK  
DOWNSTAIRS  
ON HIS  
HANDS!



RCA's new 1949 Movement and Inventory Guide helps you achieve a much larger turnover. Ask your RCA Tube Distributor for a copy.

## More profit for you in the complete line of RCA tubes

AM, FM, or TV . . . practically every make and model receiver you're called upon to service can be completely re-equipped with RCA tubes . . . from glass, metal and the latest miniatures to television kinescopes. Your RCA Distributor carries extensive stocks for your convenience.

Having the tubes your customers need . . . and the brand they prefer . . . means more business for you—from more people!

Keep up-to-date . . . ask your RCA Distributor for the following bulletins:

- *Receiving Tubes for AM, FM, and Television Broadcast (1275-D)*
- *Receiving Tube Manual (RC-15)*
- *Receiving Tube Price List (2F215R7)*
- *New 1949 Movement & Inventory Guide (2FR933)*



### STOP 1 IN 4 AND MAKE MUCH MORE!

A proved traffic stopper is this "Top Performers" display in full colors—part of a new Display Service. Ask your RCA Distributor for the latest flyer "Stop 1 in 4 and Make Much More," for complete story.

**ALWAYS KEEP IN TOUCH WITH YOUR RCA TUBE DISTRIBUTOR**



**TUBE DEPARTMENT**

**RADIO CORPORATION of AMERICA**

**HARRISON, N. J.**